



Maine Department of Health and Human Services

Maine Center for Disease Control and Prevention
286 Water Street, 3rd Floor
11 State House Station
Augusta, ME 04333-0011

Brenda M. Harvey,
Commissioner

John Elias Baldacci
Governor

Dora Anne Mills, MD, MPH
Public Health Director
Maine CDC Director

November 8, 2007

Sun-Mar Corporation
Attn.: Gord Edgar
5370 South Service Road
Burlington, Ontario L7L 5L1
Canada

Subject: Product Registration, Sun-Mar Composting Toilets

Dear Mr. Edgar:

The Division of Environmental Health has completed a review of a registration application for your company's product. This information was submitted pursuant to Section 1802 of the Maine State Plumbing Code, Subsurface Wastewater Disposal Rules (Rules), for code registration, for use in Maine.

Product Description

The Sun-Mar Composting Toilets consist of a range of models, as follow:

- Centrex 1000, Centrex 1000 NE, Centrex 1000 AC/DC.
Centrex 2000, Centrex 2000 NE, Centrex 2000 AC/DC, Centrex 2000 AF/NE, Centrex 2000 AF/NE, Centrex 2000 AF, Centrex 2000 AF, Centrex 2000 AF AC/DC, Centrex 2000 AF AC/DC.
Centrex 3000, Centrex 3000 NE, Centrex 3000 AC/DC, Centrex 3000 AF/NE, Centrex 3000 AF/NE, Centrex 3000 AF, Centrex 3000 AF, Centrex 3000 AF AC/DC, Centrex 3000 AF AC/DC.
Excel, Excel AC/DC, Excel NE Mobile, Spacesaver.

Claim

According to the information you provided, the Sun-Mar Composting Toilets have received National Sanitation Foundation Standard 41 approval.

Determination

On the basis of the information submitted, the Division has determined that the Sun-Mar Composting Toilets are acceptable for use in the State of Maine, provided that they are installed, operated, and maintained in conformance with the manufacturer's directions. In the event that the product fails to perform as claimed by the applicant, use of the product in Maine, including all installations approved pursuant to Chapter 18 of the Rules, shall cease. Use of the product shall not resume until the applicant and the Division have reached a mutually acceptable agreement for resolving the failure to perform as claimed.

Because installation and owner maintenance has a significant effect on the working order of onsite sewage disposal systems, including their components, the Division makes no representation or guarantee as to the efficiency and/or operation of Sun-Mar Composting Toilets. Further, registration of this product for use in the State of Maine does not represent Division preference or recommendation for this product over similar or competing products.

If you have any questions please feel free to contact me at (207) 287-5695.

Sincerely,

Handwritten signature of James A. Jacobsen
James A. Jacobsen, Environmental Specialist IV
Wastewater and Plumbing Control Program
Division of Health Engineering
e-mail: james.jacobsen@state.me.us

/jaj
xc: Product File

Our vision is Maine people enjoying safe, healthy and productive lives.

JAA
Jacobsen, James

From: Gord [gord@sun-mar.com]
Sent: Wednesday, November 07, 2007 10:47 AM
To: Jacobsen, James
Subject: Sun-Mar Composting Toilets
Attachments: Sun-Mar 2007-2008 Brochure for e-mail.pdf

RECEIVED
 NOV 07 2007
 WASTEWATER &
 PLUMBING PROGRAM

Hi James; It was a pleasure speaking with you today and thank you for your help in having Sun-Mar added to the list of approved products in the state of Maine. I have attached our current catalogue for your review and included the links to the NSF, as all our products are certified to their standard 41;
<http://www.nsf.org/Certified/Wastewater/Listings.asp?TradeName=&Standard=041> . I hope you will please contact me if I can do anything to help. Sincerely, Gord

Sun-Mar Products;

Sun-Mar-Excel
 Centrex 1000[1]
 Centrex 1000 NE[1]
 Centrex 1000 AC/DC[1]
 Centrex 2000[1]
 Centrex 2000 NE[1]
 Centrex 2000 AC/DC[1]
 Centrex 2000 AF/NE[1]
 Centrex 2000 AF/NE[1]
 Centrex 2000 AF[1]
 Centrex 2000 AF
 Centrex 2000 AF AC/DC[1] [2]
 Centrex 2000 AF AC/DC[1] [2]
 Centrex 3000[1]
 Centrex 3000 NE[1]
 Centrex 3000 AC/DC[1]
 Centrex 3000 AF/NE[1]
 Centrex 3000 AF/NE[1]
 Centrex 3000 AF[1]
 Centrex 3000 AF[1]
 Centrex 3000 AF AC/DC[1] [2]
 Centrex 3000 AF AC/DC[1]
 Compact
 Excel
 Excel AC/DC[1] [2]
 Excel NE[1]
 Mobile[1]
 Spacesaver

11/7/2007

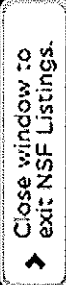
NSF Product and Service Listings

These Listings were Last Updated on **Wednesday, November 07, 2007** at 4:15 AM Eastern Time. Please contact NSF International to confirm the status of any Listing, report errors, or make suggestions.

Warning: NSF is concerned about fraudulent downloading and manipulation of website text. If you have received this listing in hard copy, always confirm this certification/listing information by going directly to <http://www.nsf.org/Certified/Wastewater/Listings.asp?Standard=041&> for the latest most accurate information.

NSF/ANSI STANDARD 41 Non-Liquid Saturated Treatment Systems



CLIVUS MULTRUM, INC.

15 UNION STREET
LAWRENCE, MA 01840
800-425-4887
978-725-5591

Facility : LAWRENCE, MA

Model Number	Rated Daily Use	Classification	Certified End Product
Model M-1 [1]	10 uses/day	Day-use Park	Solid
Model M-2 [1]	15 uses/day	Day-use Park	Solid

Model M-3 [1]	40 uses/day	Day-use Park	Solid
Model M-10 [1]	60 uses/day	Day-use Park	Solid
Model M-12 [1]	80 uses/day	Day-use Park	Solid
Model M-15 [1]	100 uses/day	Day-use Park	Solid
Model M-18 [1]	120 uses/day	Day-use Park	Solid
Model M-22 [1]	80 uses/day	Day-use Park	Solid
Model M-25 [1]	100 uses/day	Day-use Park	Solid
Model M-28 [1]	120 uses/day	Day-use Park	Solid
Model M-32 [1]	110 uses/day	Day-use Park	Solid
Model M-35 [1]	180 uses/day	Day-use Park	Solid
Model M54ADA [1]	60 uses/day	Day-use Park	Solid

[1] Systems are Certified for liquid containment, odors, and solid end products.



SUN-MAR CORPORATION

5370 SOUTH SERVICE ROAD
 BURLINGTON, ONTARIO L7L 5L1
 CANADA
 800-461-2461
 905-332-1314

Facility : BURLINGTON, ONTARIO, CANADA

Model Number	Rated Daily Use	Classification	Certified End Product
Sun-Mar-Excel	3 persons/day	Residential	Solid
Centrex 1000 [1]	5 persons/day	Cottage	Solid
Centrex 1000 NE [1]	4 persons/day	Cottage	Solid
Centrex 1000 AC/DC [1]	5 persons/day	Cottage	Solid
Centrex 2000 [1]	7 persons/day	Cottage	Solid
Centrex 2000 NE [1]	6 persons/day	Cottage	Solid
Centrex 2000 AC/DC [1]	7 persons/day	Cottage	Solid

Centrex 2000 AF/NE[1]	5 persons/day	Cottage	Solid
Centrex 2000 AF/NE[1]	3 persons/day	Residential	Solid
Centrex 2000 AF[1]	6 persons/day	Cottage	Solid and Liquid
Centrex 2000 AF	4 persons/day	Residential	Solid and Liquid
Centrex 2000 AF AC/DC[1] [2]	5-6 persons/day	Cottage	Solid
Centrex 2000 AF AC/DC[1] [2]	3-4 persons/day	Residential	Solid
Centrex 3000[1]	9 persons/day	Cottage	Solid
Centrex 3000 NE[1]	8 persons/day	Cottage	Solid
Centrex 3000 AC/DC[1]	9 persons/day	Cottage	Solid
Centrex 3000 AF/NE[1]	7 persons/day	Cottage	Solid
Centrex 3000 AF/NE[1]	5 persons/day	Residential	Solid
Centrex 3000 AF[1]	8 persons/day	Cottage	Solid and Liquid
Centrex 3000 AF[1]	5 persons/day	Residential	Solid and Liquid
Centrex 3000 AF AC/DC[1] [2]	7-8 persons/day	Cottage	Solid
Centrex 3000 AF AC/DC[1]	5 persons/day	Residential	Solid
Compact	1 persons/day	Residential	Solid and Liquid
Excel	3 persons/day	Residential	Solid and Liquid
Excel AC/DC[1] [2]	2-3 persons/day	Residential	Solid
Excel NE[1]	2 persons/day	Residential	Solid
Mobile[1]	1 persons/day	Residential	Solid
Spacesaver	1 persons/day	Residential	Solid and Liquid

[1] Systems are Certified for liquid containment, odors, and solid end products.
 [2] When used as a fully electric system the higher rating applies. When used as a non-electric system, the lower rating applies.

AC/DC - Systems that can operate as electric or non-electric
 AF - Systems that use a waterless toilet
 NE - Non-electric

Number of matching Manufacturers is 2

Number of matching Products is 41

Processing time was 0 seconds

- [Search Listings](#) |
- [News Room](#) |
- [About NSF](#) |

- [Careers](#) |
- [NSF Mark](#) |
- [Client Log-In](#)

- [Privacy Policy](#) |
- [Site Map](#) |
- [Request Info](#) |
- [Contact Us](#) |
- [Copyright © 2004 NSF International.](#)

SUN-MAR

2007-2008 Catalog

COMPOSTING TOILETS

Save the Environment...
Recycle Back to Nature!



Use Anywhere You Need A Toilet!

NO SEPTIC • NO ODOR • NO PLUMBING

CONTENTS

- 2 World Leaders for over 25 years
- Operating a SUN-MAR
- Model Overview
- Selecting a SUN-MAR
- 10 Models
- 20 Specifications of Composting Units
- 23 What Make a SUN-MAR Stand Out?
- 24 SUN-MAR Three Chamber Technology
- 25 Do-it-yourself Installation
- 30 Customer Testimonials
- 32 SUN-MAR Garden Composters



sun-Mar Corp.
600 Main Street,
Tonawanda, NY 14150-0888 USA
5370 South Service Road,
Burlington, ON L7L 5L1 Canada
Tel: 905-332-1314 • 1-888-341-0782
Fax: 905-332-1315
mail: compost@sun-mar.com
www.sun-mar.com

PROTECTING THE ENVIRONMENT FOR OVER 25 YEARS

At SUN-MAR, we are proud of the role our products play in protecting the environment.

- SUN-MAR composting toilets have saved over **.75 billion gallons** of drinking quality water, and counting.
- SUN-MAR composting toilets evaporate liquids and compost the solids, so on most models there is absolutely **no output** and no contamination of ground water.
- SUN-MAR toilets offer the safest and most **environmentally friendly** method of waste treatment.



SUN-MAR UNITS HAVE NO EQUAL!

It is no secret why SUN-MAR is the world leader in Composting toilet technology.

- Our unique, patented **ioDrum™** design provides super fast, odor free aerobic decomposition. There is absolutely nothing like it anywhere.
- SUN-MAR toilets are sold worldwide with **over 1000 dealers** in North America alone.
- SUN-MAR toilets are the **only ones certified** to ANSI/NSF standard 41 for residential use (most regulators require this certification).
- SUN-MAR **unique 3 chamber technology** guarantees simplicity of operation. Evaporation and compost removal are semi-automatic.

► For more on what makes SUN-MAR units stand out, see page 23.

► For more on how a SUN-MAR works, see pages 24 and 25.

WHAT IS COMPOSTING?

Here's a simple explanation:

- Composting converts organic matter back to its essential minerals.
- Aerobic Microbes do this in the presence of moisture and air, by oxidizing the carbon in the organic material to carbon dioxide gas, and converting the hydrogen atoms to water vapor.
- In this process, some **5%** of the starting material volume (largely moisture) is **evaporated** so the residual salts are easy to handle.
- This resulting compost provides the essential food for uptake by plants. So it is **perfect for recycling**.

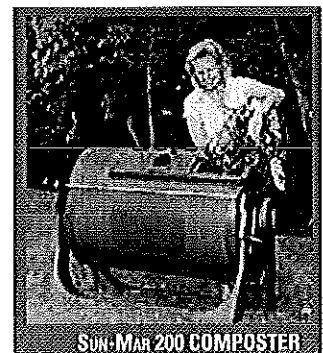

SUN-MAR 200 COMPOSTER



WHY USE A SUN-MAR COMPOSTING TOILET?

There are several reasons to use a SUN-MAR Composting Toilet.

Practical Reasons

- No Plumbing
- No Water
- No Odor
- Inexpensive Solution



Environmental Reasons

- No Pollution
- Saves Water
- Recycles Nutrients
- Little or No Liquid Output



WHEN TO USE A SUN-MAR?

A SUN-MAR can be used **ANYWHERE, ANYTIME.**

- Where there is **no plumbing** a SUN-MAR provides an instant low cost toilet.
- Where there is an **outhouse**, a SUN-MAR offers a much appreciated upgrade.
- Where the toilet waste needs to be removed from an **overloaded septic** system.
- Where there is a **water shortage** a SUN-MAR substantially reduces your water needs.
- Wherever minimizing **environmental impact** is important, a SUN-MAR is the answer.

WHERE TO USE A SUN-MAR?

A few of the most common places where a SUN-MAR is found:

- A cottage, cabin, or camp.
- A pool house, cabana, boat house or garden shed.
- Horse barns or other barns.
- Remote offices, classrooms, dormitories, workshops, gate houses or security posts.
- In a residence where it is important to make the minimum ecological footprint.
- Boats, RVs (anything that moves!)



IS A SUN-MAR ODORLESS?

Absolutely In fact customers find that there is less odor than with a traditional toilet. Proof is easy — NSF only certifies composting units that produce no odor. There is no odor for two reasons:

- SUN-MAR toilets are designed so that air is constantly being drawn in and up the vent stack to create a partial vacuum
- The Bio-Drum™, ensures a non-offensive aerobic breakdown.

▶ Air is drawn in by a fan on electric units which exhausts to a 2" vent stack, and on non-electric units by a 4" vent stack which acts like a chimney on a wood stove.

SUN-MAR IS THE ONLY NSF CERTIFIED PERFORMER

There is **only one** performance standard for composting toilets in North America. This is National Sanitation Foundation (NSF) Standard #41-1999.

SUN-MAR units are certified by NSF for residential and/or seasonal use. For verification, check NSF listed products at: www.nsf.org/Certified/Wastewater/Listings.asp?TradeName=&Standard=041

- ▶ This standard is a stringent one which explains why only SUN-MAR is certified by NSF. It involves testing for 6 months at a NSF recognized independent testing laboratory under a strict test protocol. To be certified the unit must operate at maximum capacity (including overload conditions) with no odors and produce clean, safe compost. As additional verification, NSF obtains and tests additional compost samples from randomly selected units in regular field operation, and conducts interviews with the users of these units.
- ▶ Our testimonials are great, but in the end, they are no substitute for certification by NSF. What they have certified you can rely on. Our conservative capacity ratings have been certified by NSF.

WINTER USE Limited Winter Use

For limited use in cold temperatures you can use the unit as a **holding tank** so long as there is enough space in the Bio-drum™.

- If the compost is frozen avoid rotating the drum.
- If you have an electrical unit plug it in while in use so that the fan will eliminate any odors

Extended Winter Use

For extended winter use the composting unit has to be **kept warm** for composting to continue.

- ▶ Insulate vent piping on all units to avoid icing.
- ▶ Where applicable insulate inlet piping and drain piping.
- ▶ If heating the space around the composter is not practical, consider insulating the area, and putting in an electric or propane space heater.
- ▶ Keep electric units plugged in to minimize the chance of freezing.
- ▶ Reduce energy costs by installing a fan speed control on electric units. This reduces cold air intake and heater operation.

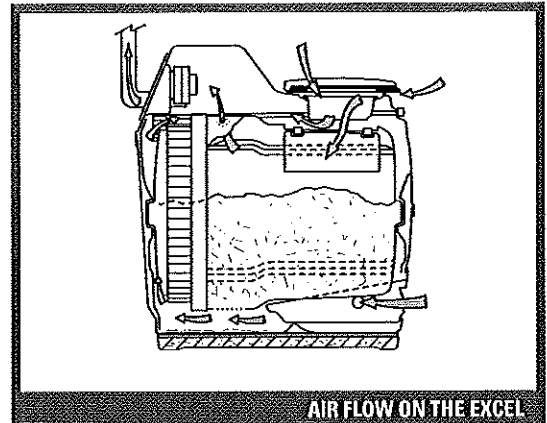

certified to meet
Australian Standards



certified to comply with applicable
European Product Safety Standards and
satisfies the provision for CE marking



SEMKO (Sweden) Certified
for 220 Volt units

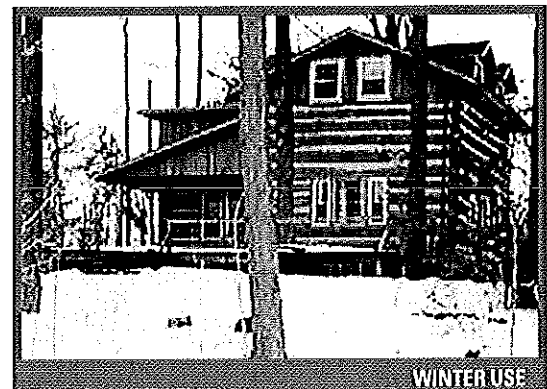

OPERATING A SUN-MAR

Start-up

Start-up is simple. Everything you need is included with the unit.

- Add some Peat mix bulking material called "Compost Sure" to the Bio-drum™.
- Add some special microbes called "UN-MAR Microbe Mix".

That's it. You are ready to start using your SUN-MAR just like a regular toilet, even including your **regular toilet paper**. Amazingly, a UN-MAR can easily compost this toilet paper along with the waste.

Ongoing Operation

For ongoing operation all you need to do is:

- Add a cupful of Peat Mix ("Compost Sure") at the rate of one cupful per person per day of use.
- **very 2-3 days** while the toilet is in use, pull out the drum handle (recessed on most self-contained units) and rotate the drum 4-6 complete revolutions. For weekend use just rotate the drum before you leave at the end of the weekend.

Removing Compost

Removing Compost is Quick & Easy.

- **Release** the drum lock and **rotate the drum backwards** into the **finishing drawer**







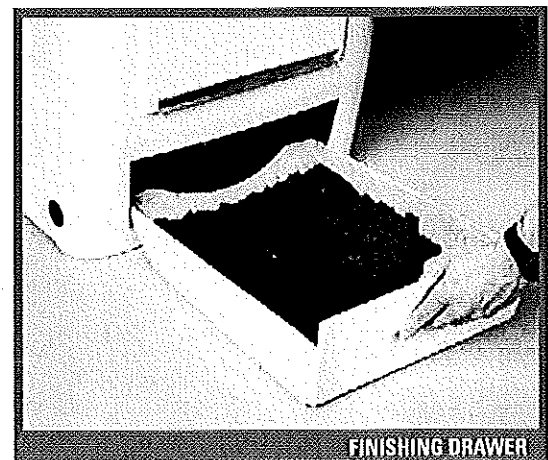
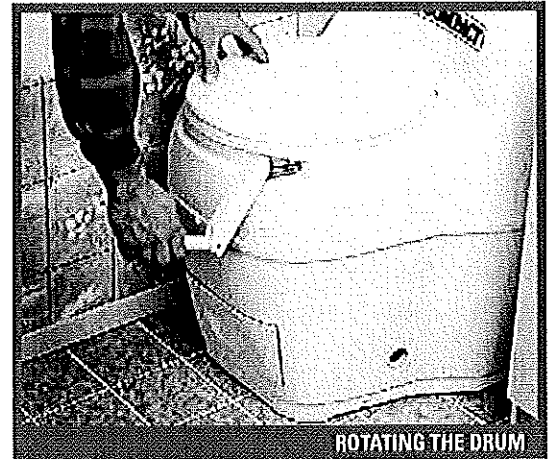



- ▶ *This entire process takes less than a minute, and most importantly you don't come into contact with fresh material.*
- ▶ *In cottage use some composted material (fertilizer) is normally removed in the spring to make room for the next seasons operation. In continuous use, compost will have to be dropped into the finishing drawer more often. Here it is sanitized before the next cycle when the drawer is removed, emptied and the empty drawer replaced.*

« We use the cottage 6 months of the year and we empty some compost only in the spring. »

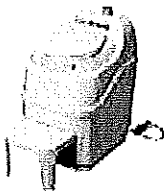
Bernie Purdy, ON
Centrex 1000 NE



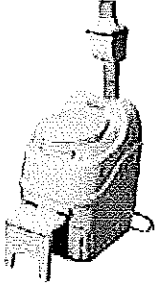







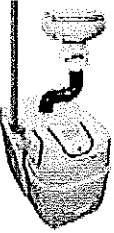

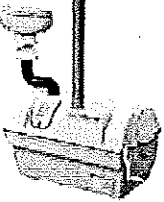
Model Overview — Self Contained Units

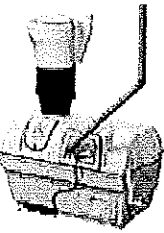
SELF-CONTAINED	Model	Description	Composting Capacity		Voltage	Page #
			Weekend/Vacation	Residential/Continuous		
	 EXCEL	High Capacity Electric Unit	Adults or families of 8	Adults or Family of 4	15V	10
EXCEL						
	 COMPACT	Medium Capacity Electric Unit	3 Adults or family of 4	Adult	15V	12
COMPACT						
	 PACESAVER	Medium Capacity Electric Unit	Adults or family of 4	Adult	15V	12
SPACESAVER						
	 EXCEL NE	Non-electric Unit	Adults or family of 7	2 Adults or Family of 3	12V Fan Optional	10
EXCEL NE						
	  MOBILE	Dual Voltage Unit	Adults or family of 4	Adult	12V & 115V (115V Optional)	2
MOBILE						
<i>The Excel Mobile, a marinized Excel, is available where space exists and the Mobile has insufficient capacity.</i>						

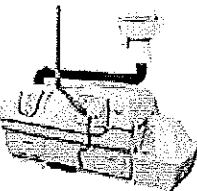
Central Units – Model Overview

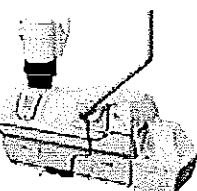
(toilets purchased separately)

CENTRAL	Model	Description	Toilet	Composting Capacity		Voltage	Page #
				Weekend/ Vacation	Residential/ Continuous		
	 ENTREX 1000	Reg. Capacity Electric Unit	One Pint Flush Toilet	Adults or Families of 7	N/A	115V	4
	 ENTREX 1000 NE	Reg. Capacity Non-electric Unit	One Pint Flush Toilet	4 Adults or Families of 6	N/A	12V .4W Fan Optional	4
CENTREX 1000							
	 ENTREX 2000	High Capacity Electric Unit	One Pint Flush Toilet	7 Adults or Families of 9	4 Adults or Family of 6	115V	16
	 ENTREX 2000 NE	High Capacity Non-electric Unit	One Pint Flush Toilet	6 Adults or Families of 8	Adults or Family of 5	12V .4W Fan Optional	16
CENTREX 2000 NE							
	 ENTREX 2000 A/F	High Capacity Electric Unit	One Pint Flush Toilet	Adults or Families of 8	4 Adults or Family of 6	115V	16
	 ENTREX 2000 A/F NE	High Capacity Non-electric Unit	One Pint Flush Toilet	Adults or Families of 7	Adults or Family of 5	12V .4W Fan	16
CENTREX 2000 A/F							
<i>AC/DC versions of all central units (One Pint Flush and Water Free types) are also available. These are dual vented units with both 2" and 4" vent stacks and can operate either as a standard electric unit or with a 12 Volt 1.4 or 2.4 Watt DC fan. See page 27.</i>							
	 ENTREX 3000	Extra High Capacity Electric Unit	One Pint Flush Toilet	Adults or families of 11	Adults or Families of 8	115V	18
	 ENTREX 3000 NE	Extra High Capacity Non-electric Unit	One Pint Flush Toilet	Adults or Families of 10	Adults or Families of 7	12V .4W Fan Optional	18
CENTREX 3000							
	 CENTREX 3000 A/F	Extra High Capacity Electric Unit	One Pint Flush Toilet	8 Adults or Families of 10	5 Adults or Families of 7	115V	18
	 ENTREX 3000 A/F NE	Extra High Capacity Non-electric Unit	One Pint Flush Toilet	7 Adults or Families of 9	5 Adults or Families of 7	12V 2.4W DC Fan	18
CENTREX 3000 A/F							

SELECTING A SUN-MAR

At SUN-MAR we know that because we have so many different models, it is important to make the model selection process as straight forward as possible. SUN-MAR has six product families. **Three are self-contained** product families which are installed directly in the bathroom. **Three are central** product families where a toilet is installed in the bathroom with the composting unit below.

Follow these **THREE** steps to determine the right model for you:

1

SELF-CONTAINED OR CENTRAL UNITS

Self-contained Units

These units are installed directly in the bathroom. On electric units, 2" vents exit **top rear** so the vent can be installed **invisibly** by running through the bathroom wall and up the outside.

- **Water Free**
- **Quick and easy to install**
- **Easy to winterize**
- **Economical** because they are one piece systems.
- Electrical units can normally **evaporate all liquids**
- **Easy to clean** having a durable shiny finish.

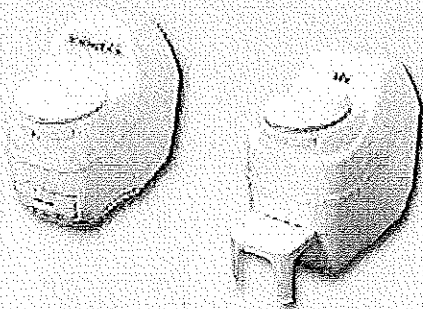

Self-contained Units

Central Units

These units are placed **below the toilet** and are available either as a **Water Flush** unit with an extra low flush toilet, or as a **Water Free (AF)** unit with a SUN-MAR Dry Toilet.

Water Free Central Units

- Feature a "traditional looking" toilet in the bathroom.
- **Must be directly below** the toilet.
- **Vaporate all or most** of the liquid.
- Require no flushing liquid.

Water Flush Central Units

- Feature a "traditional looking" toilet in the bathroom with waterseal.
- **Must be within 15-20 feet** of the toilet.
- Require a drain connection.
- **Can handle multiple** toilets.

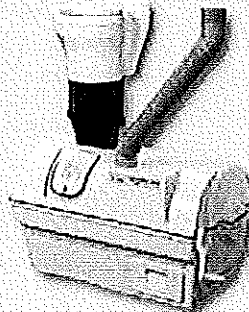

Water Free Unit



Water Flush Unit

2

ELECTRIC, NON-ELECTRIC OR AC/DC

Electric Units

If you have a standard electricity supply, a regular electrical unit would be the choice. These units feature high quality squirrel cage blower fans, thermostatically controlled heaters and 2" vent stacks. Mobile units have 12 Volt fans and 15 Volt heaters.

AC/DC Units

If you are expecting 115 Volt power in the future, have frequent power outages or are running a generator for 12 or more hours per day, select a dual vented AC/DC unit.

This unit is a regular electric unit with 2" vent which uses a 12 Volt DC fan in a separate 4" vent stack when regular 115 Volt power is not available. A 12 Volt DC fan is included with all AC/DC units.

Non-Electric Units

If you have no power or are using alternative energy, select an NE (non-electric) unit.

These units feature a 4" vent stack. A 12 Volt fan is not included unless the unit is used residentially or if there are special circumstances. See Installing a 12 Volt fan on page 27.

3

CAPACITY AND COLOR

Capacity

Finally, pick a unit with the right capacity for your needs. Keep in mind that although advertised capacities can be doubled for short periods, SUN-MAR has found that wherever possible it is always better to have a good margin of safety. So, pick a unit with more capacity than you really need.

Color

Self-contained units other than Mobile units are available in **white** as well as the standard **one** color.

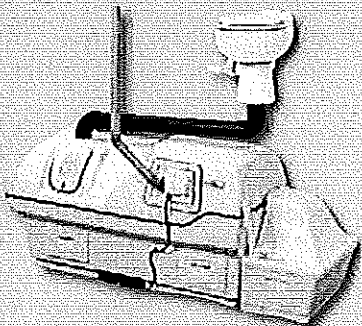

Extra High Capacity

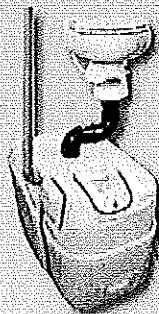

Regular Capacity

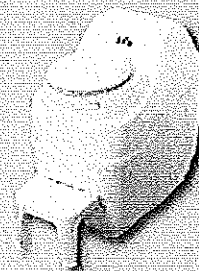

White

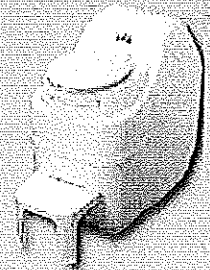

Bone

EXCEL — High Capacity Self-Contained Units

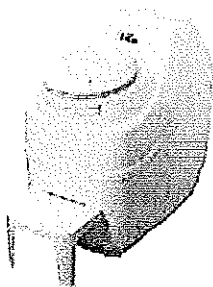
EXCEL	MAIN FEATURES	APPLICATION
 <p style="text-align: center;">High Capacity Electric</p>	<p>Color: White or Bone Fan: 5W turbo-fan Heater: 260W 115V thermostatically controlled Vent: 2" stack Drain: ½" Emergency drain hook up (optional)</p>	<p>Anywhere there is continuous 115 Volt electricity and high composting and evaporating capacities needed.</p>

*Composting Capacity: Weekend and Vacation 6 adults or families of 8 • Residential and Continuous 3 adults or families of 4

EXCEL NE	MAIN FEATURES	APPLICATION
 <p style="text-align: center;">High Capacity Non-Electric</p>	<p>Color: White or Bone Fan: /A Heater: N/A Vent: 4" stack Drain: 1" required</p>	<p>Where continuous AC electricity is not available. 2 Volt DC fan is not required except in special circumstances, see page 28.</p>

*Composting Capacity: Weekend and Vacation 5 adults or families of 7 • Residential and Continuous 2 adults or families of 3

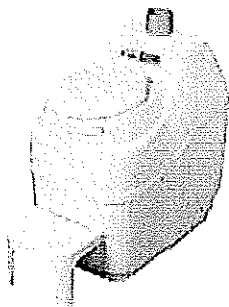
EXCEL AC/DC	MAIN FEATURES	APPLICATION
 <p style="text-align: center;">Dual Vented High Capacity</p>	<p>Color: White or Bone Fan: 1.4W 12V DC fan when continuous AC not available Heater: 260W 115V thermostatically controlled Dual Vent: 2" & 4" stack Drain: 1" required</p>	<p>Where power is expected in the future, or where there are frequent power outages.</p>

*Composting Capacity: Either as EXCEL or EXCEL NE — see above

► *Advertised capacities can be doubled for short periods.

EXCEL

Canada's former Governor General recently described herself as "totally and utterly an evangelist" for her 11 year old Excel NE toilet. Certainly the Excel family is impressive and distinctive, but that's what you would expect from the best selling composting toilet in North America.

All three versions of the Excel (electric, non electric, and dual mode AC/DC) have the same large composting drum, which is what gives this family both its distinctive look and its outstanding performance.

Evaporation performance of the electric unit is such that the Excel is NSF certified to evaporate all liquids even under overload conditions. Even so, as a safety measure SUN-MAR recommends hooking up the safety drain where the Excel is to be used heavily or residentially.

All Excel family units feature a detachable footrest which can be put aside whenever you need to access the finishing drawer.

The durable, smooth, shiny finish make the Excel family and all other SUN-MAR units easy to clean.

- ▶ For installation considerations, see pages 26 to 29.
- ▶ For detailed specifications, see page 20.

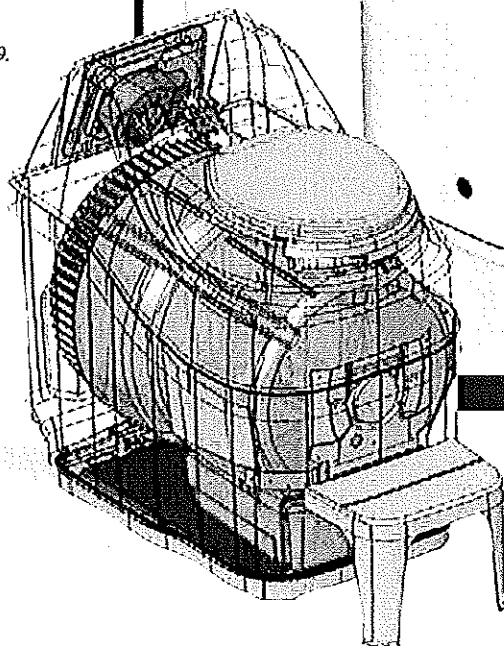
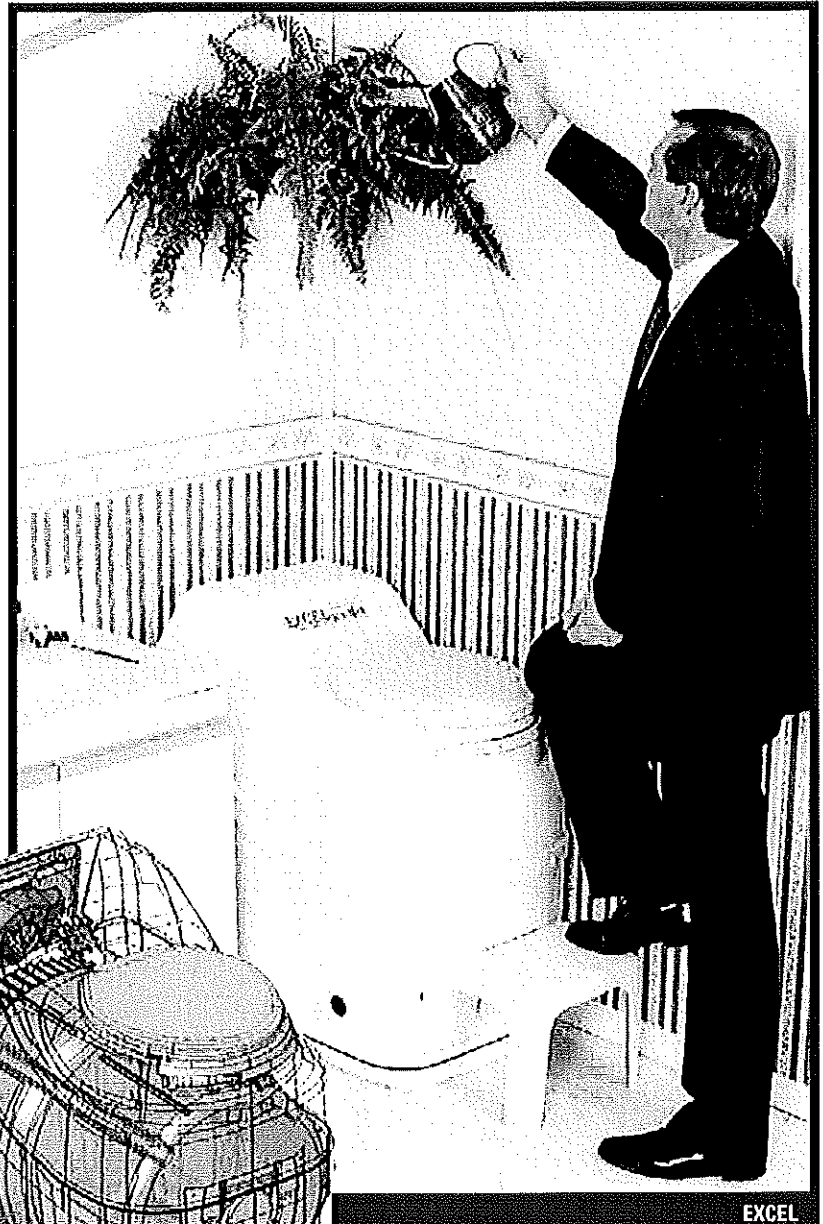

“ We look forward to 15 more years of happy composting with our ecologically sound Excel toilet system. ”

- Nancy Steiger, SK
Excel (Residential)

COMPACT — Medium Capacity Self-Contained Unit

COMPACT	MAIN FEATURES	APPLICATION
 <p style="text-align: center;">Medium Capacity Electric</p>	<p>Color: White or Bone Fan: 35W turbo-fan Heater: 200W thermostatically controlled Vent: 2" stack Drain: 1" (Emergency drain hook-up optional)</p>	<p>Suitable for use anywhere where continuous 115 Volt electricity is available and high composting capacity is not needed. Good evaporating performance.</p>
<p>*Composting Capacity: Weekend and Vacation 3 adults or families of 4 • Residential and Continuous 1 adult</p>		

SPACESAVER — Medium Capacity Self-Contained Unit

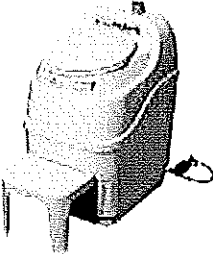
SPACESAVER	MAIN FEATURES	APPLICATION
 <p style="text-align: center;">Medium Capacity</p>	<p>Color: White or Bone Fan: 35W turbo-blower Heater: 120W 115V thermostatically controlled Vent: 2" stack Drain: 1" safety drain (hook-up optional) Footprint: 21 1/2" x 19 1/2"</p>	<p>Where there is continuous 115 Volt electricity but little space.</p>
<p>*Composting Capacity: Weekend and Vacation 3 adults or families of 4 • Residential and Continuous 1 adult</p>		

MOBILE — Medium Capacity Self-Contained Unit

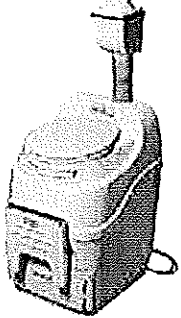
MOBILE	MAIN FEATURES	APPLICATION
 <p style="text-align: center;">Medium Capacity</p>	<p>Color: Bone only Fan: 4.0W 12V Heater: 160W 115V thermostatically controlled Vent: 3" stack Drain: 1" safety drain (hook-up required) Footprint: 21 1/2" x 19 1/2"</p>	<p>Boats, RVs or any other place where there is 12 Volt power but space is at a premium.</p>
<p>*Composting Capacity: Weekend and Vacation 3 adults or families of 4 • Residential and Continuous 1 adult</p>		

▶ **Advertised capacities can be doubled for short periods.*

COMPACT

The Compact is an **elegant, low profile, medium capacity** unit with the looks to complement any bathroom. It is especially popular for cabanas, guest houses, or any remote place where there is an electrical connection but no plumbing.

The unique Compact Bio-drum™ allows seat height to be only slightly higher than a “regular” toilet which makes the unit ideal for the elderly or handicapped.

The Compact comes only as an electrical model, there is not a non-electric or AC/DC version available.

► For detailed specifications, see page 20.

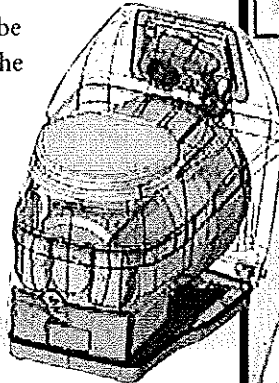

COMPACT

SPACESAVER

This family of units are engineered specifically for use **where space is extremely limited**. The footprint of these units is so small it is only slightly wider and longer than a regular sized toilet seat.

The Spacesaver requires a continuous supply of AC power. Its 2” vent stack exits top rear which makes installation easy, even where only a **closet or small corner** is available. The removable footrest allows easy access to the finishing drawer when needed.

MOBILE

Designed for use on **boats and RVs**, the US Coast Guard approved Mobile unit has a 3” vent with a 12 Volt 4 Watt fan in the stack. This unit allows people to travel wherever they want without worrying about pump-outs. Now at last people can **recycle their own waste** without polluting the waters.

► For detailed specifications, see page 20.

► For more on Mobile unit operation, see page 28.

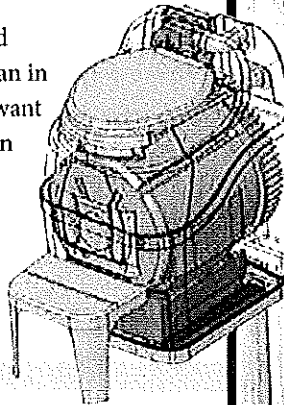

SPACESAVER

“We installed the Compact after struggling without success with another brand of composting toilet for many years. It works wonderfully!”

— Louise Perkins, PA
Compact

Models – CENTREX 1000

CENTREX 1000 – Regular Capacity Central Units

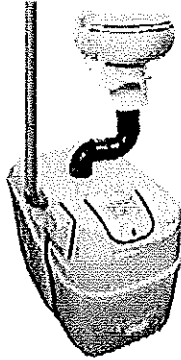
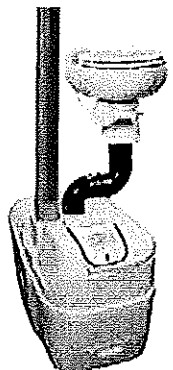
CENTREX 1000 – WATER FLUSH	MAIN FEATURES	APPLICATION
 <p data-bbox="251 745 609 777">Regular Capacity Slimline Electric</p>	<p data-bbox="690 388 950 630"> Color: Bone Fan: 35W turbo-fan Heater: 260W 115V thermostatically controlled Vent: 2" stack Drain: 1" drain (hook-up required) </p>	<p data-bbox="1015 388 1388 441">For use with One Pint Flush Toilet where continuous 115 Volt power is available.</p>
<p data-bbox="154 798 966 829">*Composting Capacity: Weekend and Vacation: 5-7 • Residential and Continuous: N/A</p>		
CENTREX 1000 NE – WATER FLUSH	MAIN FEATURES	APPLICATION
 <p data-bbox="203 1249 609 1281">Regular Capacity Slimline Non-Electric</p>	<p data-bbox="690 892 950 1113"> Color: Bone Fan: 1.4W 12V optional (not supplied) Heater: N/A Vent: 4" stack Drain: 1" drain (hook-up required) </p>	<p data-bbox="1015 892 1404 976">Regular capacity unit for use with One Pint Flush Toilet where there is no continuous 115 Volt power.</p>
<p data-bbox="154 1291 966 1323">*Composting Capacity: Weekend and Vacation: 4-6 • Residential and Continuous: N/A</p>		

▶ * Advertised capacities can be doubled for short periods.

OPERATION OF CENTRAL UNITS

On central units, **waste and bulking material** enter the drum through double input door on the **left of the drum** (rear on CENTREX 3000).

Bulking material can be added every two or three days or, for weekend use, at the end of the weekend, by opening the input port on the left.

Central units have an output door at the right of the unit. Compost can be extracted by releasing a drum lock, and rotating the drum backwards. Now the input doors stay shut, the **output door is open** and compost *drops automatically* into the finishing drawer at the right of the unit.

On **Centrex 3000 units** it is not necessary to rotate the drum backwards to extract compost. Here compost moves *automatically* into a **collection chamber** at the end of the unit.

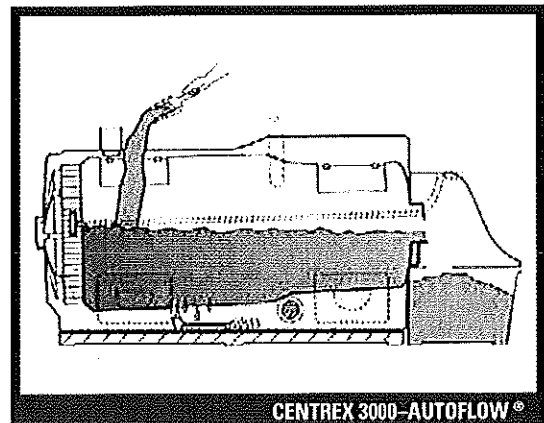

CENTREX 1000

The Centrex 1000 is suited to narrow spaces being only 22 3/4" wide. It is the ideal central unit for **light to medium seasonal use**. Used in this way it has enough capacity to last a complete season without having to extract any compost.

► For operation details, see pages 26 to 29.

The CENTREX 1000 is **only available** for use with **One Pint Flush Toilets** (purchased separately).

No AF (water free) version is available. The CENTREX 1000 is offered in three types (an electric, non-electric and a combination AC/DC model) for use with a One Pint Flush Toilet.

- An AC/DC version of the Centrex 1000 (water flush) is available if required. The AC/DC is a standard electrical unit with the addition of a 4" vent stack and an optional 12 Volt fan. This allows the AC/DC to operate as an electric unit when power is available and as a non-electric unit when it is not.
- The AC/DC is ideal for where power is expected to be available shortly, or where the unit is in an area subject to frequent power outages.
- For detailed specifications, see page 21.

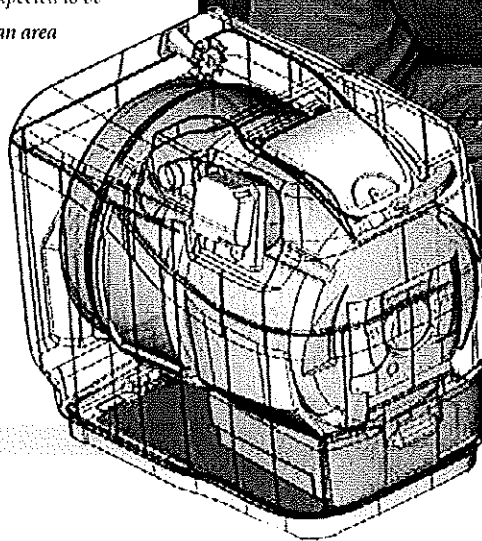
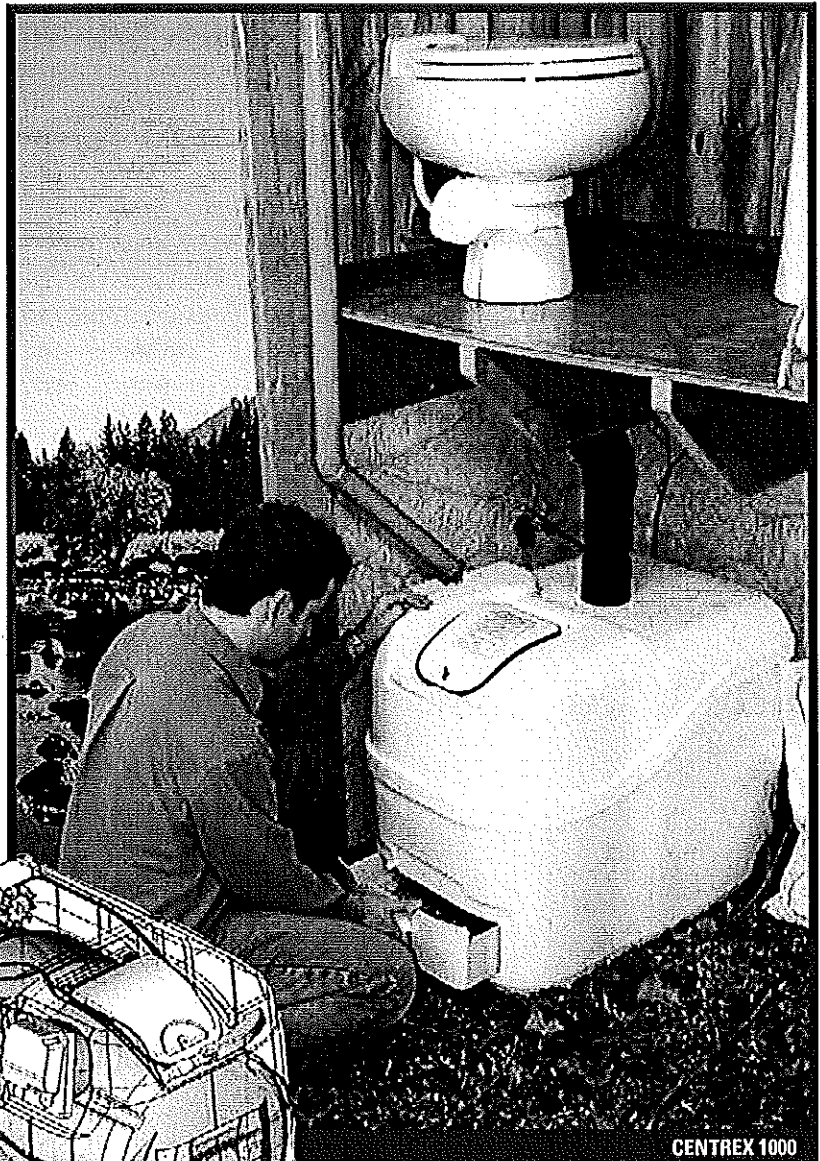

“ Our cabin is on a hillside. No place to put a septic system, even if we wanted one. The environment office suggested a compost unit when I called for a site inspection. ”

E.M.Otto, ON
Centrex 1000

CENTREX 2000 — High Capacity Central Units

CENTREX 2000 — WATER FLUSH

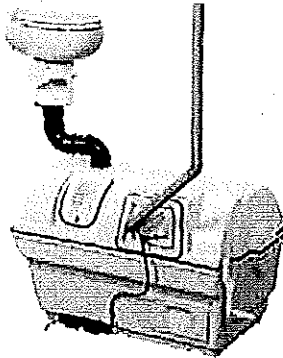

High Capacity Electric Water Flush

MAIN FEATURES

- Color:** Bone
- Fan:** 35W turbo-fan
- Heater:** 370W 115V thermostatically controlled
- Vent:** 2" stack
- Drain:** 1" required for water flush, optional for water free

CENTREX 2000 AF — WATER FREE

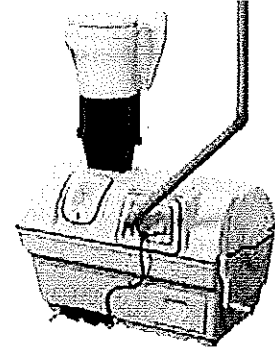

High Capacity Non-Electric Water Free

***Composting Capacity:**

000 Water Flush: Weekend and Vacation: 7-9 • Residential and Continuous: 4-6
 000 AF Water Free: Weekend and Vacation: 6-8 • Residential and Continuous: 4-6

CENTREX 2000 NE — WATER FLUSH

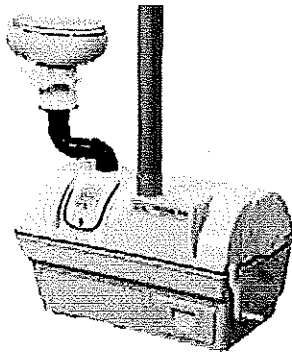

High Capacity Non-Electric Water Flush

MAIN FEATURES

- Color:** Bone
- Fan:** 2.4W 12V DC
- Heater:** /A
- Vent:** 4" stack
- Drain:** 1" drain hook-up required)

CENTREX 2000 AF NE — WATER FREE

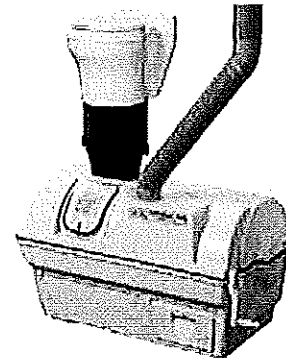

High Capacity Non-Electric Water Free

***Composting Capacity:**

000 NE Water Flush: Weekend and Vacation: 6-8 • Residential and Continuous: 3-5
 000 AF NE Water Free: Weekend and Vacation: 5-7 • Residential and Continuous: 3-5

- ▶ An AC/DC version of both the 2000 Water free (AF) and water flush units is available if required. The AC/DC is a standard electrical unit with the addition of a 4" vent stack and an optional 12 Volt fan. This allows the AC/DC to operate as an electric unit when power is available and as a non-electric unit when it is not. The AC/DC is ideal for where power is expected to be available shortly, or where the unit is in an area subject to frequent power outages.
- ▶ * Advertised capacities can be doubled for short periods.

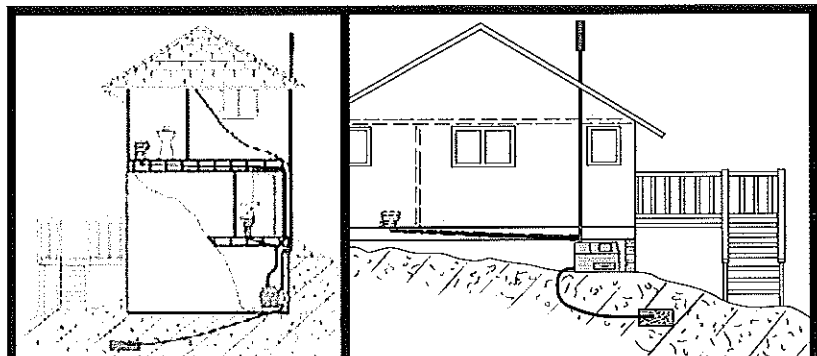

A TYPICAL INSTALLATION WITH TWO ONE PINT FLUSH TOILETS

TOILET CONNECTED WITH WASTE PIPING DROPPING AT 1/4" TO 1/8" PER FOOT.

CENTREX 2000

The CENTREX 2000 family is a **high capacity** unit, featuring a Bio-drum™ 50% larger than the CENTREX 1000. It is designed to have enough capacity to last a **complete cottage season** without extracting any compost, a capability that was proven by NSF when this unit was successfully tested at their facility.

► For operation details, see pages 24 to 25 and page 14.

The **water flush version** of the CENTREX 2000 is offered in three types (an electric, non-electric and a combination AC/DC model) for use with a One Pint Flush Toilet (purchased separately).

These same three types are also available as CENTREX 2000 AF (water free) versions for use with a SUN-MAR Dry Toilet (also purchased separately). These AF (water free) units are particularly popular where there is a shortage of water, or where it is desired to minimize or eliminate liquid output. NSF testing indicated that there was minimal liquid output on CENTREX 2000 AF NE (water free non-electric) units, and **none on electric units.**

► For detailed specifications, see page 21.

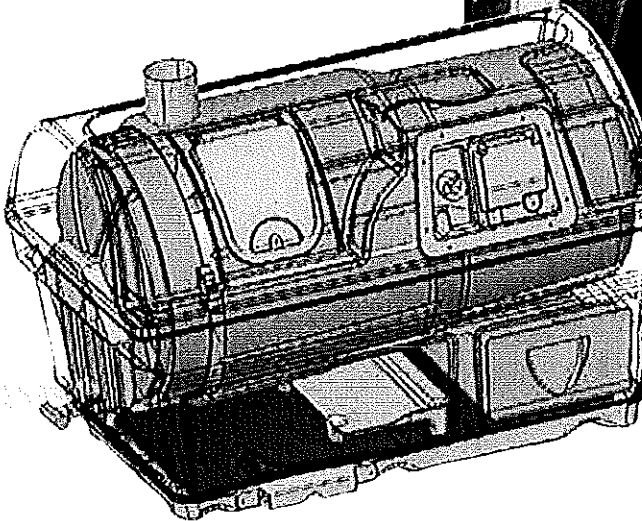
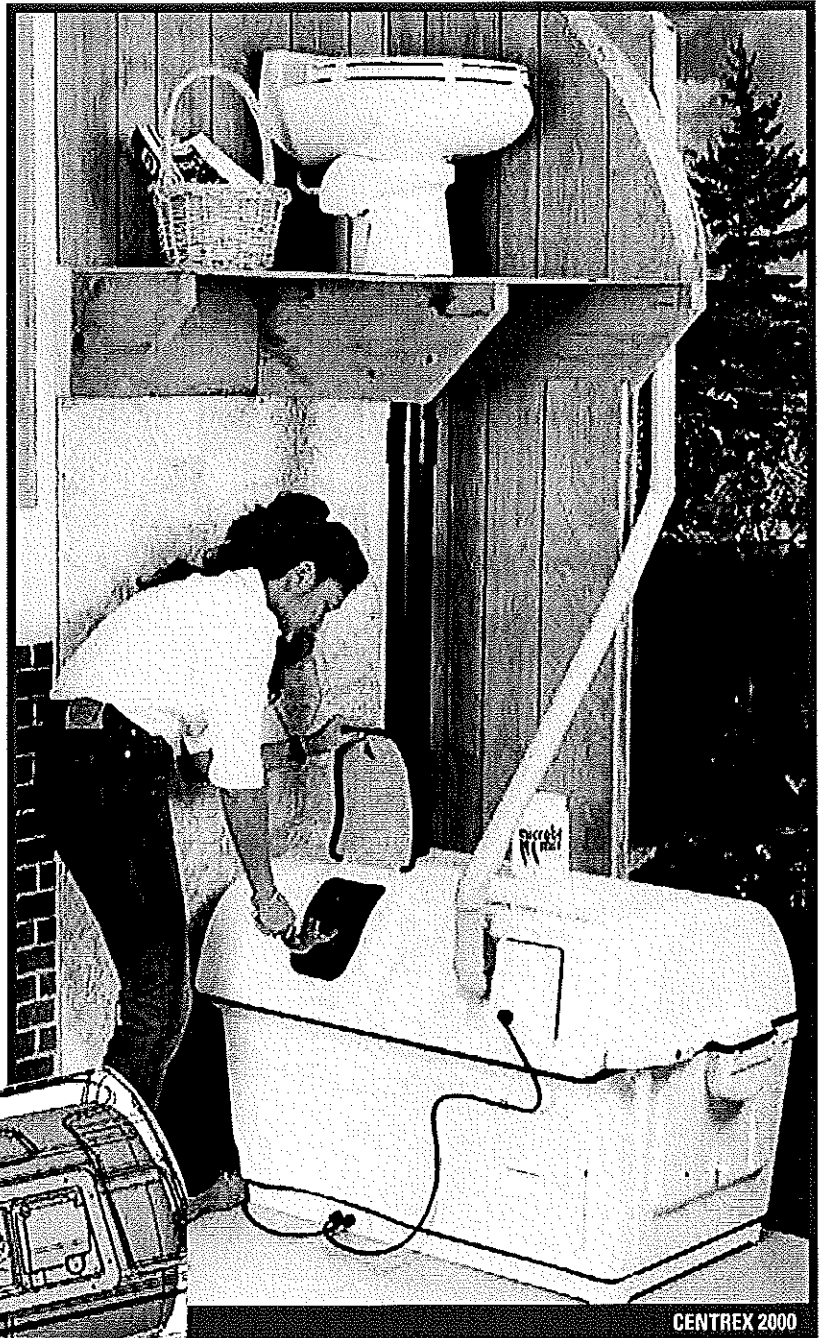

“The Centrex 2000 works great...

We have absolutely no regrets!”

– The Arasons, MB
Centrex 2000

CENTREX 3000 — Extra High Capacity Central Units

CENTREX 3000 — WATER FLUSH

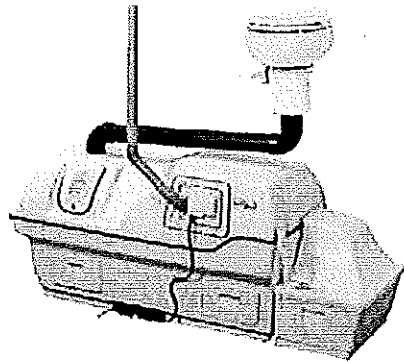

Extra High Capacity Electric Water Flush

MAIN FEATURES

- Color: Bone
- Fan: 35W turbo-blower
- Heater: 370W 115V thermostatically controlled
- Vent: 2" stack
- Drain: 1" drain required for water flush, optional for water free

CENTREX 3000 AF — WATER FREE

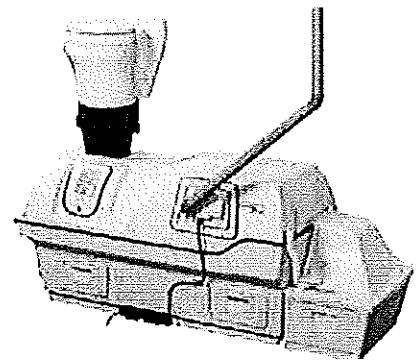

Extra High Capacity Non-Electric Water Free

***Composting Capacity:** 000 Water Flush: Weekend and Vacation: 9-11 • Residential and Continuous: 6-8
 000 AF Water Free: Weekend and Vacation: 8-10 • Residential and Continuous: 5-7

CENTREX 3000 NE — WATER FLUSH

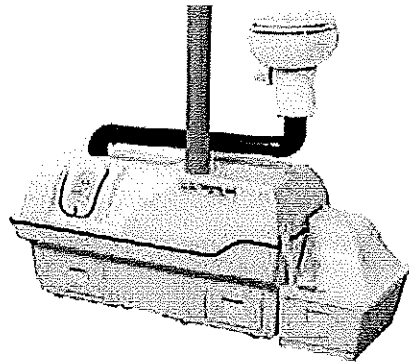

Extra High Capacity Non-Electric Water Flush

MAIN FEATURES

- Color: Bone
- Fan: 2.4W 12V DC
- Heater: /A
- Vent: 4" stack
- Drain: 1" drain hook-up required)

CENTREX 3000 AF NE — WATER FREE

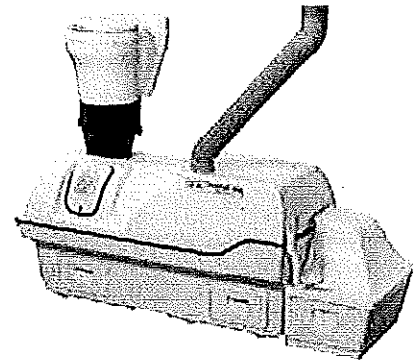

Extra High Capacity Non-Electric Water Free

***Composting Capacity:** 000 NE Water Flush: Weekend and Vacation: 8-10 • Residential and Continuous: 5-7
 000 AF NE Water Free: Weekend and Vacation: 7-9 • Residential and Continuous: 5-7

- ▶ An AC/DC version of both the 3000 water flush and 3000 AF water free is available if required. The AC/DC is a standard electrical unit with the addition of a 4" vent stack and an optional 12 Volt fan. This allows the AC/DC to operate as an electric unit when power is available and as a non-electric unit when it is not. The AC/DC is ideal for where power is expected to be available shortly, or where the unit is in an area subject to frequent power outages.
- ▶ * Advertised capacities can be doubled for short periods.

“ We produce an average of two five gallon pails of compost per season. Its great, easy, inexpensive and an excellent system. ”

Gary O'Brien, MA
 Centrex 3000

CENTREX 3000

The CENTREX 3000 family is a revolutionary **high capacity** unit which embodies SUN-MAR's unique Autoflow® technology. As the drum rotates, compost moves *automatically* through the drum and finally into a separate collection chamber at the end of the unit. This means that unlike other SUN-MAR units there is no need to rotate the drum backwards to extract compost.

► For operation details, see pages 24 to 25 and page 14.

The **Water Flush version** of the CENTREX 3000 is offered in three types (an electric, non-electric (NE) and a combination AC/DC model) for use with a One Pint Flush Toilet (purchased separately). These same three types are also available as CENTREX 3000 AF (**Water Free**) units for use with a SUN-MAR Dry Toilet.

► For detailed specifications, see page 21.

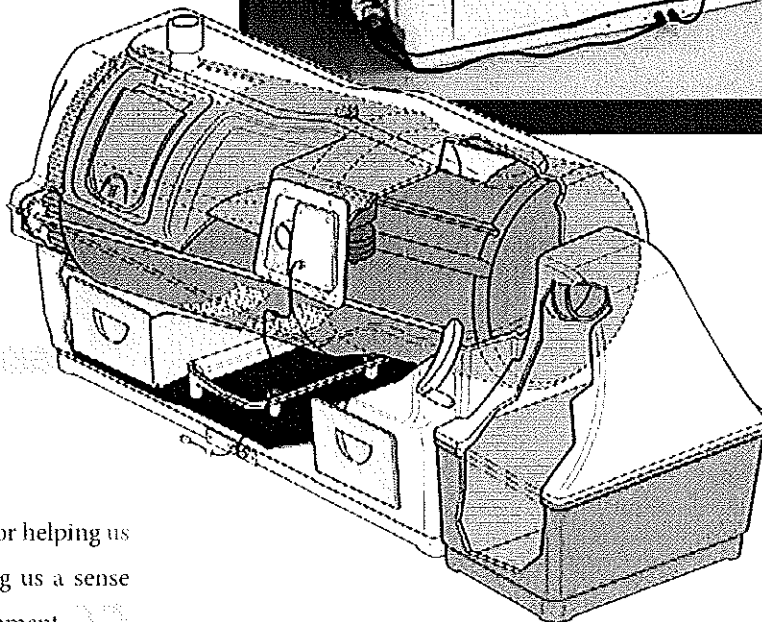
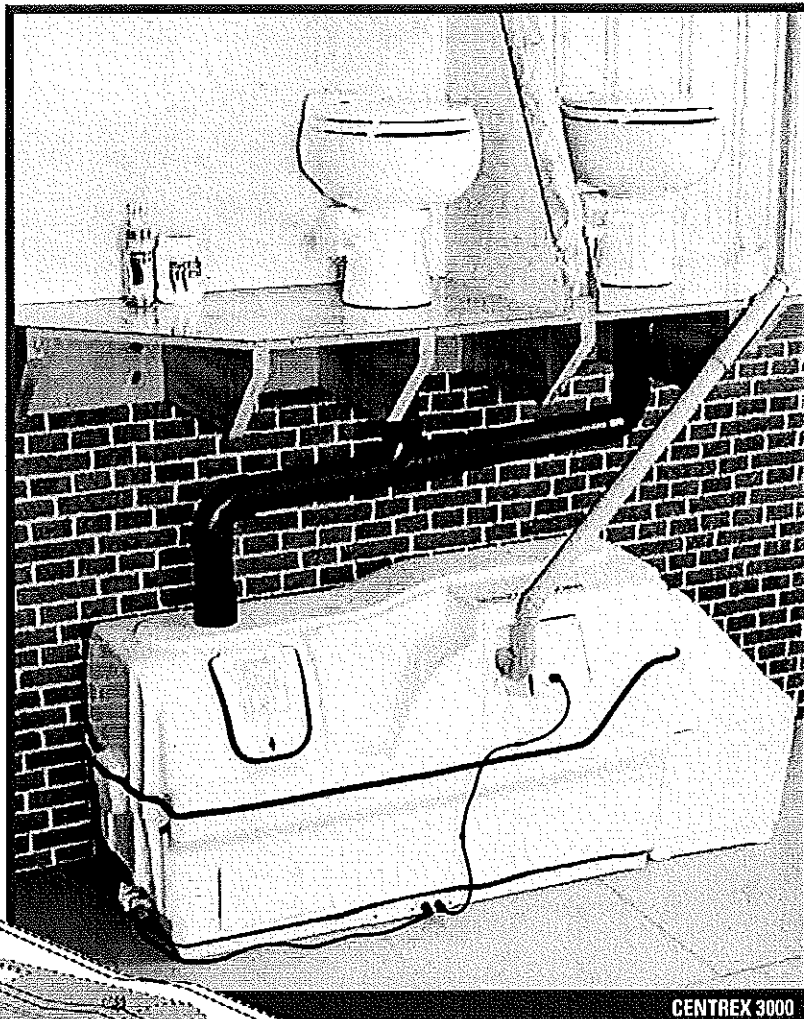

☺ Thanks, SUN-MAR, for helping us save water, and giving us a sense of helping the environment. ☺

— Peter & Carol Radcliff, CO
Centrex 3000

Specifications of Composting Units – Self-contained Units

Self-Contained Units	Excel	Compact	Space Saver	Excel AC/DC	Excel NE	Mobile
Composting Capacity						
Residential & Continuous Use (Adults – Families*)	3A – 4F	1A – 2F	1A – 2F	3A – 4F or 2A – 3F	2A – 3F	1A – 2F
Weekend & Vacation Use (Adults – Families*)	6A – 8F	3A – 4F	3A – 4F	6A – 8F or 5A – 7F	5A – 7F	3A – 4F
Electrical						
Max. Amps (with heater on)	2.4	2.0	1.2	2.4	NA	1.0
Fan Watts (required or optional hook-up)	35 req.	35 req.	35 req.	35 or 1.4 opt.	1.4 (12V) opt.	4.0 (12V) req.
Heater Watts (when thermostat switches it on)	260	200	160	260	NA	160**
Average Power Use in Watts (heater on 1/2 time)	150	125	110	150	NA	80
Unit Dimensions (inches)						
Height (unit only)	33 $\frac{1}{2}$	28 $\frac{1}{2}$	30	33 $\frac{1}{2}$	31 $\frac{1}{2}$	30
Depth (unit only)	33	33	23	33	32 $\frac{1}{2}$	23
Width (unit only)	22 $\frac{1}{2}$	21 $\frac{1}{2}$	19 $\frac{1}{2}$	22 $\frac{1}{2}$	22 $\frac{1}{2}$	19 $\frac{1}{2}$
Height Footrest (when in use)	10 $\frac{1}{2}$	NA	10 $\frac{1}{2}$	10 $\frac{1}{2}$	10 $\frac{1}{2}$	11 $\frac{1}{2}$
Height (footrest to seat)	18	NA	17	18	17	17
Footprint (width x depth)	—	—	—	—	—	17 $\frac{1}{2}$ x 19 $\frac{1}{2}$
Vent & Drains						
Vent Pipe (2" cent. vac. tubing; 3" & 4" sewer)	2"	2"	2"	2" & 4"	4"	3"
Drains (required or optional hook-up)	$\frac{1}{2}$ " opt.	$\frac{1}{2}$ " opt.	1" req.	1" req.	1" req.	1" req.
Weights (lbs.)						
Product Weight – Shipping Weight	60 – 100	50 – 90	40 – 75	60 – 110	50 – 95	45 – 80
Shipping Carton Dimensions (inches)						
Width	28	28	22	28	28	22
Length	35 $\frac{1}{2}$	35 $\frac{1}{2}$	29	35 $\frac{1}{2}$	35 $\frac{1}{2}$	29
Height	36	30 $\frac{1}{2}$	37	36	36	37
Rough-in Measurements (inches)						
Depth required to remove drawer	46	45	38	46	46	38
Vent outlet center distance from left side (looking at back of unit)	8 $\frac{1}{2}$	7 $\frac{1}{2}$	7	11 $\frac{1}{2}$ & 8 $\frac{1}{2}$	11 $\frac{1}{2}$	7
Height to center of vent	28 $\frac{1}{2}$	23 $\frac{1}{2}$	27 $\frac{1}{2}$	28 $\frac{1}{2}$	NA	NA
Height to top of vent outlet assembly	NA	NA	31 $\frac{1}{2}$	36	35	33
Depth with footrest on applicable units	41 $\frac{1}{2}$	NA	31	41 $\frac{1}{2}$	41 $\frac{1}{2}$	30

* Family numbers include adults and small children. **Additional 12V 120 Watt heater available as option.

Central Units – Specifications of Composting Units

Central Units – GENTREX 1000 & 2000	1000	1000 NE	1000 AC/DC	2000	2000 NE	2000 AC/DC	2000 A/F	2000 A/F NE	2000 A/F AC/DC
Composting Capacity									
Residential & Continuous Use (Adults – Families*)	NA	NA	NA	4A – 6F	3A – 5F	4A – 6F or 3A – 5F	4A – 6F	3A – 5F	4A – 6F or 3A – 5F
Weekend & Vacation Use (Adults – Families*)	5A – 7F	4A – 6F	5A – 7F or 4A – 6F	7A – 9F	6A – 8F	7A – 9F or 6A – 8F	6A – 8F	5A – 7F	6A – 8F or 5A – 7F
Electrical									
Maximum Amps	2.5	NA	2.5/NA	3.6	NA	3.6/NA	3.6	NA	3.3/0.28
Fan Watts (required or optional hook-up)	35 req.	1.4 opt.	35 req./1.4 opt.	35 req.	1.4 opt.	35 req./2.4 opt.	35 req.	2.4 req.	35 req./2.4 opt.
Heater Watts (when thermostat switches it on)	260	NA	260	370	NA	370	370	NA	350
Average Power Use in Watts (heater on 1/2 time)	150	NA	150	200	NA	200	200	NA	200
Unit Dimensions (inches)									
Height & Depth	28 1/2 x 32 1/2	27 1/2 x 32 1/2	28 1/2 x 32 1/2	28 x 27	26 1/2 x 26 1/2	28 x 27	28 x 27	26 1/2 x 26 1/2	28 x 27
Unit Width, and Width Required to Turn Handle	22 1/2 x 24 1/2	22 1/2 x 24 1/2	22 1/2 x 24 1/2	45 1/2 x 49	45 1/2 x 49	45 1/2 x 49	45 1/2 x 49	45 1/2 x 49	45 1/2 x 49
Vent & Drains									
Vent Pipe (2" cent. vac. tubing; 4" sewer)	2"	4"	2" & 4"	2"	4"	2" & 4"	2"	4"	2" & 4"
1" Drains (required or optional hook-up)	req.	req.	req.	req.	req.	req.	opt.	req.	req.
Weights (lbs.)									
Product Weight – Shipping Weight	50 – 95	45 – 90	50 – 100	97 – 118	87 – 108	103 – 124	103 – 124	93 – 114	108 – 129
Shipping Carton Dimensions (inches)									
Width – Length – Height (inches)	28-35-31 1/2	27-35-36	27-35-36	28 1/2-47-30	28 1/2-47-36	28 1/2-47-36	28 1/2-47-31	28 1/2-47-36	28 1/2-47-36
Rough-in Measurements (inches)									
Depth Required to Remove Drawer	46 1/2	46 1/2	46 1/2	45	45	45	45	45	45
Height to Bottom – Top of Waste Inlet Assembly	26 1/2 – 29 1/2	25 1/2 – 28 1/2	26 1/2 – 29 1/2	27 1/2 – 31	26 1/2 – 29 1/2	27 1/2 – 31	27 1/2 – 33	26 1/2 – 31 1/2	27 1/2 – 33
Vent Inlet Center Distance From Rear – Left Side	17 1/2 – 1 1/2	17 – 4 1/2	Both	11 – 12	11 – 12	11 – 12	11 – 12	11 – 12	11 – 12
Waste Inlet Diameter (including flange)	3" DWV	3" DWV	3" DWV	3" DWV	3" DWV	3" DWV	10 1/2"	10 1/2"	10 1/2"
Height to Center or Top of Vent Outlet Assembly	26 1/2	30 1/2 (top)	Both	23 1/2	32 (top)	Both	23 1/2	32 (top)	Both
Central Units – GENTREX 3000**									
	3000	3000 NE	3000 AC/DC	3000 A/F	3000 A/F NE	3000 A/F AC/DC			
Composting Capacity									
Residential & Continuous Use (Adults – Families*)	6A – 8F	5A – 7F	5-6A – 7-8F	5A – 7F	5A – 7F	5-6A – 7-8F			
Weekend & Vacation Use (Adults – Families*)	9A – 11F	8A – 10F	8A – 11F or 8A – 10F	8A – 10F	7A – 9F	8A – 10F or 7A – 9F			
Electrical									
Max. Amps	3.6	NA	3.6	3.6	NA	3.6			
Fan Watts (required or optional hook-up)	35 req.	2.4 opt.	35 req./2.4 opt.	35 req.	2.4 req.	35 req./2.4 req.			
Heater Watts (when thermostat switches it on)	370	NA	370/NA	370	NA	370/NA			
Average Power Use in Watts (heater on 1/2 time)	215	3.4 opt.	215/3.4 opt.	215	2.4 opt.	215/2.4 opt.			
Unit Dimensions (inches)									
Height – Depth – Width (including collection housing 13 1/2")	30 1/2 x 27 1/2 x 71	29 1/2 x 27 1/2 x 71	30 1/2 x 27 1/2 x 71	30 1/2 x 27 1/2 x 71	29 1/2 x 27 1/2 x 71	30 1/2 x 27 1/2 x 71			
Vent & Drains									
Vent Pipe (2" cent. vac. tubing; 4" sewer)	2"	4"	2" & 4"	2"	4"	2" & 4"			
1" Drains (required or optional hook-up)	req.	req.	req.	opt.	req.	req.			
Weights (lbs.)									
Product Weight – Shipping Weight	102 – 172	88 – 164	107 – 194	108 – 178	94 – 170	113 – 200			
Shipping Carton Dimensions (excluding skid)									
Width – Length – Height (inches)**	28 – 60 1/2 – 36 1/2	28 – 60 1/2 – 36 1/2	28 – 60 1/2 – 36 1/2	28 – 60 1/2 – 36 1/2	28 – 60 1/2 – 36 1/2	28 – 60 1/2 – 36 1/2			
Rough-in Measurements (inches)									
Depth Required to Remove Drawer	45 1/2	45 1/2	45 1/2	45 1/2	45 1/2	45 1/2			
Height to Top of Waste Inlet Assembly	32 1/2	31 1/2	32 1/2	35 1/2	34 1/2	35 1/2			
Vent Inlet Center Distance From Rear – Left Side	24 – 37 1/2	19 1/2 – 37 1/2	Both	24 – 37 1/2	19 1/2 – 37 1/2	Both			
Waste Inlet Diameter (including flange)	3" DWV	3" DWV	3" DWV	10 1/2"	10 1/2"	10 1/2"			
Height to Center or Top of Vent Outlet Assembly	24 1/2	33 (top)	Both	24 1/2	33 (top)	Both			

* Family numbers include adults and small children. **All 3000 units come with collection chamber in a second box approximately 16"x24"x23".

TOILET SELECTION

One Pint Flush

Requiring about one pint of water per flush, our ceramic One Pint Flush Toilets provide all the advantages of a regular flush toilet while **minimizing water usage**. Available in white or bone, and having a regular sized toilet seat, more than one toilet can be installed with CENTREX water flush systems. The limitation is with the number of people using the toilet rather than the number of toilets.

► For the way a One pint Toilet works see page 28

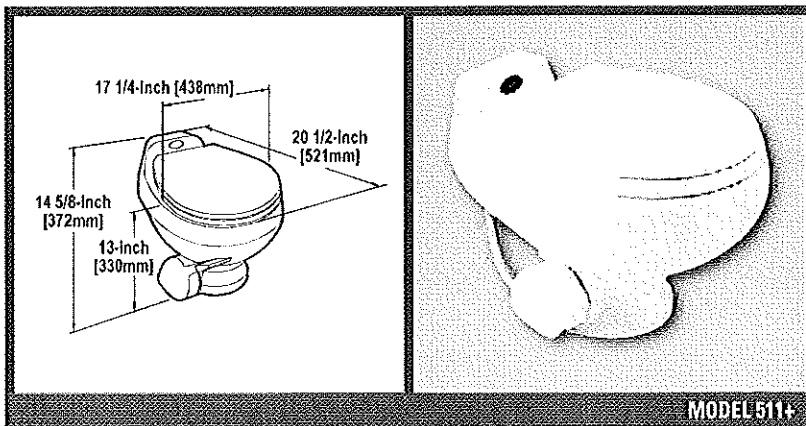
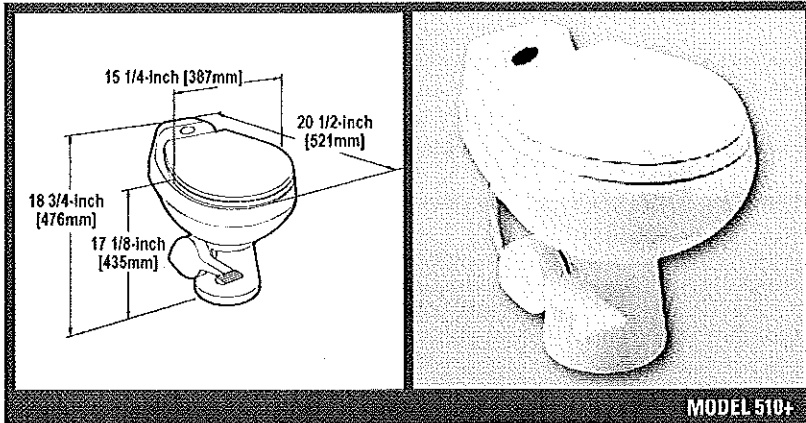

“ This unit has been trouble free.
I highly recommend your product. ”

- J Zanotti, PA
Centrex 1000

Water Free Dry

The elegant and sturdy SUN-MAR Dry Toilet is designed for use with all **ENTREX AF (Water Free) systems**. Available in white or bone, the Dry Toilet has a seat height of 15" and a regular sized toilet seat. Dry Toilets include a bowl liner hat fits beneath the seat and can be removed for cleaning as required.

CENTREX AF (Air Flow) units use **no flushing liquid** and are connected by a straight 10" diameter pipe piece to the CENTREX AF unit **directly beneath the toilet**

► On these units, odorless operation is ensured by creating a partial vacuum in the compostor, and drawing air continuously down through the toilet seat. See page 28.

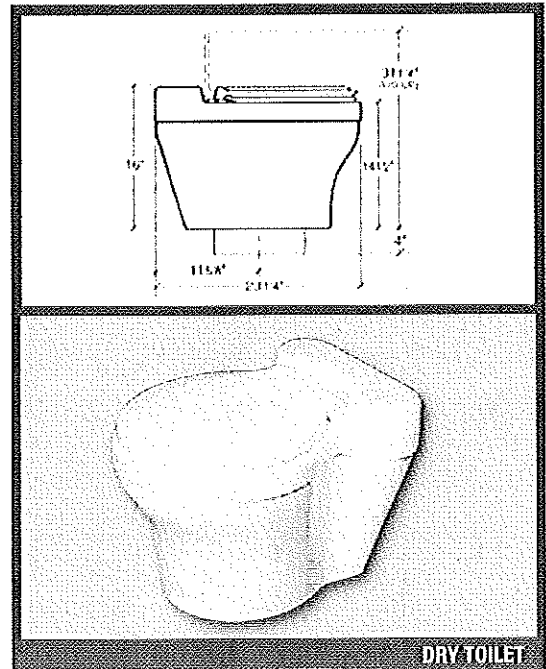

WHY SUN-MAR HAS NO EQUAL

Overall

- With its patented Bio-Drum™, SUN-MAR is the only Company that is certified and listed by the National Sanitation Foundation (NSF) as having passed North America's composting toilet performance standard for residential and cottage use.
- Our capacity figures are realistic and are certified by NSF.
- Our units can handle up to 8 people in continuous residential use and occasional cottage loads of up to 22 people.
- SUN-MAR technology features separate optimized chambers for composting, for evaporation, and for compost finishing.
- We feature over 150 testimonials on our web site, and outstanding after sales customer service.
- We have displaying dealers throughout North America, chances are there is one close to you.
- SUN-MAR features 23 standard models, to ensure you have the right model for your situation.
- Our continuous flow and 3 chamber technologies are unique, and all models are covered by one or more of our international patents.

Composting

- SUN-MAR incorporates a composting drum (the Bio-Drum™) into all units.
- Five different sized drums are needed for different capacities.
- Our Bio-Drum™ ensures the compost is kept moist, mixed, and oxygenated.
- Operation is simple, the drum is rotated only at the end of the weekend (for cottage use) and every two or three days in continuous use.
- Our units compost toilet paper easily.
- Bio-Drums™ are easy to operate, there are no mechanical parts to get stuck.
- Extracting compost is as easy as releasing the drum lock and rotating the drum backwards.

Compost Finishing

- SUN-MAR technology features a compost finishing drawer which isolates the compost from contamination.
- This separation ensures that removing compost is as simple as pulling out a drawer. No tools are needed.

Evaporation

- Our evaporation system works automatically.
- The engineered air flow on our units evaporate the liquids without drying out the compost.
- This is done by pulling air over a large, warmed evaporating surface.
- SUN-MAR's superior evaporation uses little power per liter evaporated.
- Our turbo-blower fan is resettable, and features adjustable re-circulation, stainless shaft and ball bearings for long life.

“We are really pleased with our compost toilet. The township inspector gave it the “thumbs up” as well. We would recommend it to anyone.”

— Pat & Mary Madaleno, ON
Centrex 2000

Three Chamber Technology



THREE CHAMBER TECHNOLOGY

Composting toilets must **compost** the waste, **evaporate** the liquid, and provide for safe and **easy handling** of the finished compost. Not surprisingly the conditions needed for each task are different. In the past SUN-MAR found that failure to separate these functions in different chambers led to potential disaster with floods, to compost with brick-like consistency, and contamination by fresh waste. SUN-MAR avoids these problems with its **three chamber system** where conditions are optimized for each chamber.

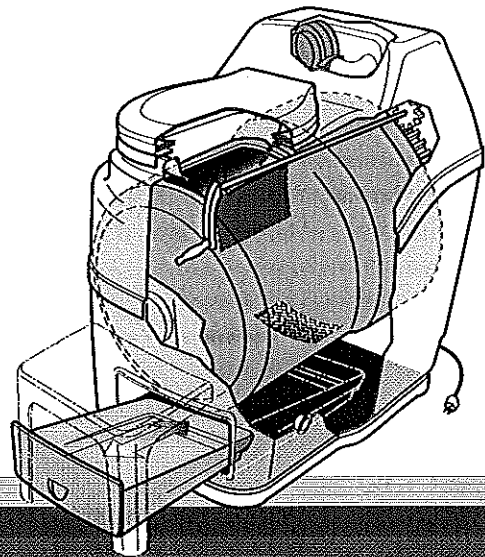

The Advantages of the SUN-MAR Bio-drum™

Common sense suggests that a drum would offer the ideal environment for composting, and indeed the patented SUN-MAR Bio-drum™ has a unique set of advantages.

The Bio-drum™ Composting Chamber

- Tumbling the Bio-drum™ optimizes **mixing and aeration** and allows for moisture to be evenly distributed.
- The Bio-drum™ ensures there is **no excess moisture** by removing it automatically directly into the evaporating chamber through a screen. The Bio-drum™ is separated from direct heat in the evaporation chamber, so the compost is kept moist.
- The Bio-drum™ offers unmatched **simplicity of operation**. To mix and aerate merely turn the Bio-drum™ handle periodically. To extract compost a drum lock is released and the Bio-drum™ rotates backwards, automatically dropping compost into a separate finishing drawer.
- By providing perfect mixing, oxygenation, and moisture control, the Bio-drum™ offers an **ideal environment** for **aerobic bacteria** to flourish and quickly break down organic material.

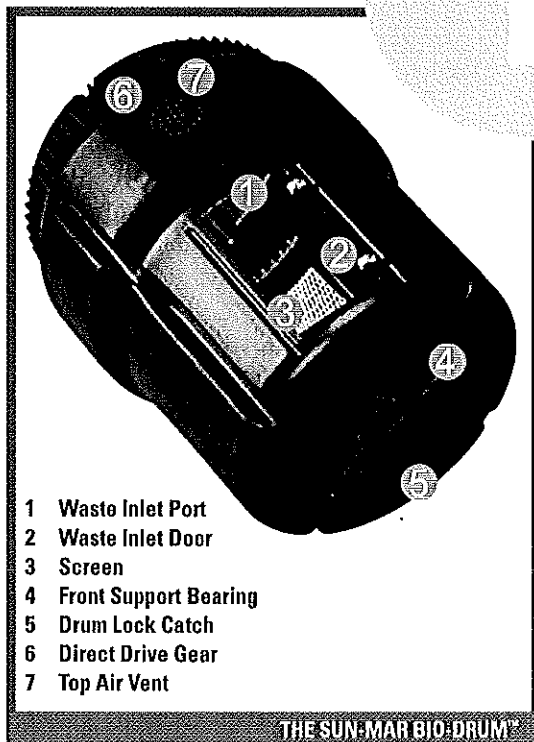

2

The Advantages of the SUN-MAR Automatic Evaporating System

The SUN-MAR evaporation chamber offers the ideal environment for evaporation. It has a large evaporating surface with thermostatically controlled heat and lots of air movement.

The Evaporating Chamber

- The floor of the unit below the drawer is the **evaporating chamber**. The large evaporating surface is accessed simply by pulling out the drawer.
- Electric units have a **thermostatically controlled heater** in a sealed compartment below the evaporating chamber. This heater is on continuously **only** when there is liquid to evaporate in the chamber.
- On electric units a long lasting squirrel cage **turbo fan** pulls air into the unit to ensure odorless operation, and over the evaporating surface to **optimize evaporation**.
- The fan setting can be adjusted to optimize the mix between recirculated and vented air for every installation.
- **Non-electric units** rely on their **4" vent stack** to provide some evaporation from passive venting, but overflow drains must always be connected on these units. Evaporation and air movement on non-electric units can be enhanced by installing a **12 Volt DC fan** in the vent stack **if required**.

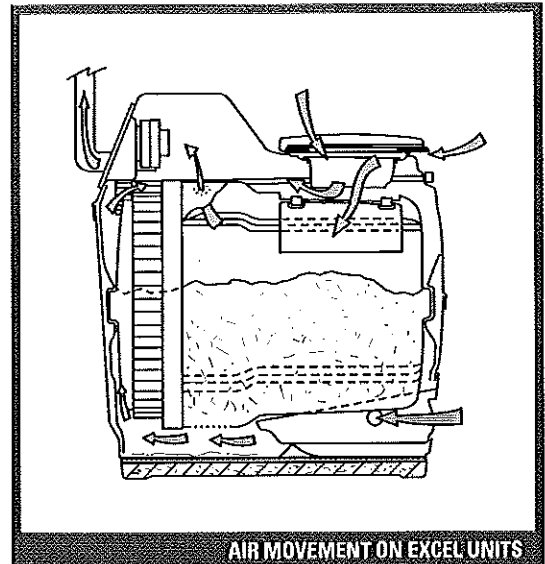

3

The Advantages of the Unique SUN-MAR Finishing Drawer

The SUN-MAR finishing drawer (or collection chamber on CENTREX 3000 family units) is an isolated container, into which finished compost drops automatically when the Bio-drum™ is rotated backwards (forwards on CENTREX 3000 units). Here the compost can be left to complete the composting and sanitation process.

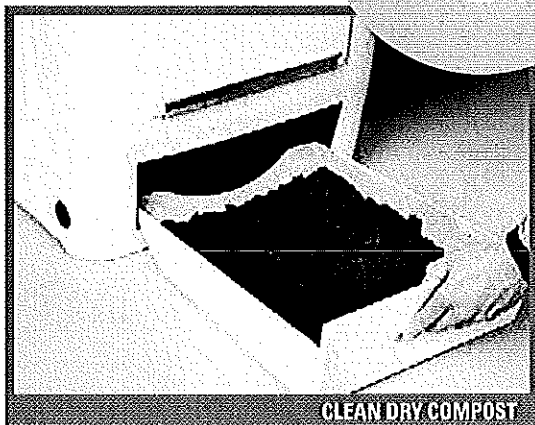

The Collection Chamber/Finishing Drawer

- While in the drawer the compost is surrounded by a stream of drying air, and gradually dries out prior to removal.
- The finishing drawer is **pulled out by hand**, with no tools needed and no screws to undo. The sanitized compost can be removed, emptied and the empty drawer replaced whenever more compost needs to be extracted from the Bio-drum™.
- For seasonally used units, several drawers of compost are removed in the spring so as to make room in the drum for that year's operation.

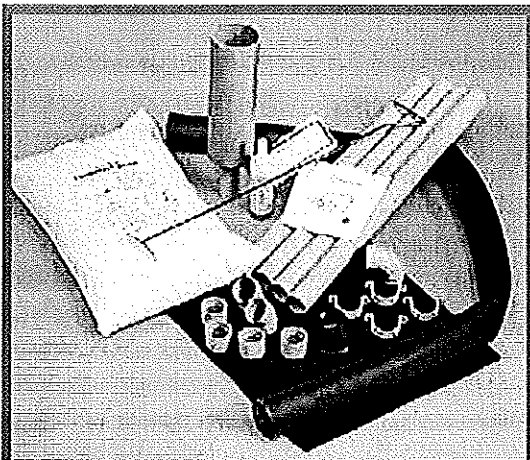

EXCEL, COMPACT & CENTREX ELECTRIC UNITS CARTONS



EXCEL NE CARTON

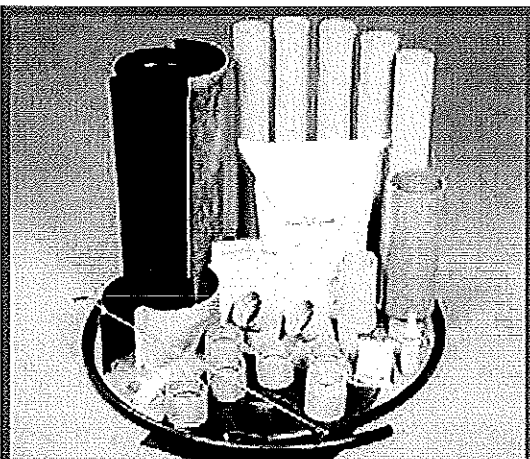

CENTREX 2000 A/F NE AND CENTREX 3000 A/F NE CARTON

WHAT'S IN THE BOX?

SUN-MAR units are designed for easy Do-It-Yourself installation, and there are no "extras or options" you will need to buy to get your unit going.

Everything you will need is included in the box.

The only exception is that those buying a water flush Central unit will need to buy the 3" plumbing pipe and fittings needed to connect the One Pint Flush Toilet to the Composting unit.

All Units Include:

- An owner's manual.
- Warranty card.
- Peat mix (30L bag) for starting off the unit.
- Rake for periodic clearing of the evaporating chamber.
- "Compost Quick" enzyme for speeding up composting.
- "Microbe Mix" bacteria for inoculating waste.

Some Units Include:

- 10' of 1" diameter drain hose and clamp for all units. (*Excel and Compact units N/A*)
- Roof flashing and diffuser for 2", 3" or 4" pipe as appropriate. (*Mobile units N/A*)
- 6' of 2" pipe insulation. (*Excel and Compact units*)
- Removable evaporating tray for placing in the evaporating chamber below the drum screen. (*Central units*)
- 45" long pipe piece and waste inlet transition assembly to connect toilet to compostor. (*Central AF - water free units*)
- 3" waste inlet assembly. (*All Central - water flush units*)

The Vent Stack

Electric self-contained and Central units have 2" vent stacks of 10ft and 15ft respectively (central vacuum pipe). All have the necessary connectors, two 45° fittings and one 90° elbow.

Non-electric self-contained and central units have 8ft and 13ft respectively of 4" vent stacks (sewer pipe) along with necessary connectors. AF (water free) central non-electric units have two 45° elbows.

All AC/DC units have a complete 4" vent kit in addition to a 2" vent stack, and a 1.4 Watt 12 Volt fan except for the 2000 and 3000 AC/DC which have a 2.4 Watt 12 Volt fan.

► For more on Mobile units, see page 28.

☺☺ Installation was a 'Snap', I installed it myself in less than 2 hours. I have nothing but praise for the SUN-MAR. ☺☺

- Mr. Weidner, KS.
Spacesaver

INSTALLING THE VENT STACK

All composting units need to have the vent stack **connected to the unit** and erected as straight as possible to the roof with no horizontal runs. All electrical units use a 2" vent pipe, non-electric units use a 4" pipe, and Mobile units use 3" pipe (sewer pipe).

► For details on possible vent configurations, see drawing on this page.

The vent kits included in the shipping carton are sufficient for installation in most single storey buildings. If more is needed, they are normally easy to find in Canada. In the USA, purchase a rubberized coupling to connect to the SUN-MAR supplied pipe if necessary.

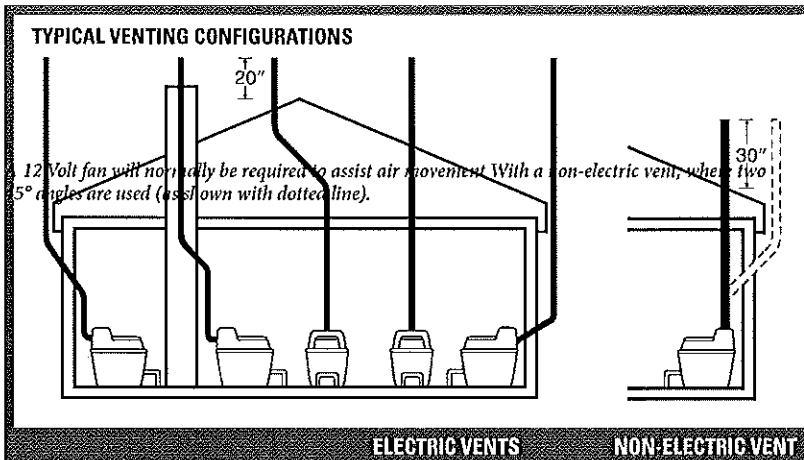

With a non-electric vent, where two 45° angles are used (as shown with dotted line), a 12 Volt fan will normally be required to assist air movement.

- Electric units with 2" vents should have the minimum number of bends which should not exceed 360° in total. 45° elbows should be used wherever possible. No pipe run should be horizontal however short.
- 3" and 4" vents should be installed as straight as possible. If a 4" vent requires 45° elbows, then a 12 Volt fan should be included in the vent stack.
- Merging a SUN-MAR vent with other existing vents risks interference and is not advised.
- The diffuser included with all but mobile units is a simple but effective device originally patented by SUN-MAR to aid updraft, avoid winter freeze up, and protect the vent from downdraft and weather.
- As shown in the drawings they should be installed 2-3 feet above the peak of the roof.

When a 12 Volt fan is needed

A 12 Volt fan is not normally needed with the Excel NE, CENTREX 1000 NE and CENTREX 2000 NE. With a vertical 4" vent stack, the chimney effect ensures there will be no odor in the bathroom. An optional 12 Volt 1.4 Watt fan is available should it ever be needed.

SUN-MAR recommends installation of a 12 Volt fan in the 4" vent stack under the following circumstances:



- If the unit is to be used residentially or heavily.
- If the vent stack has one or more 45° angles.
- If the installation is subject to downdraft being in a valley and/or surrounded by tall trees.

A 12 Volt 1.4 Watt fan is included with Excel AC/DC and CENTREX 1000 AC/DC units.

A 12 Volt 2.4 Watt fan is included with CENTREX 3000 NE, all A/F and AC/DC units.

12 Volt fans can be powered by a solar panel and/or battery.

ELECTRICAL INSTALLATION

All electric units are supplied with a power cord, which plugs into a standard three pin 115 Volt outlet and powers both the fan and heating element. The only exception to this is the SUN-MAR Mobile, which includes separate plugs for 12 Volt and 115 Volt components.

TOILET INSTALLATION FOR CENTRAL UNITS

All Central units require a toilet in the bathroom to be connected to the composting unit.

Units Using One Pint Flush Toilets

- *Mount flush toilets* to the floor with a 3" diameter four bolt flange (not supplied), and connect your water supply to the 1/2" MPT fitting at the rear of the toilet. You will require a 1/2" FPT fitting to mate your water supply with this fitting on the toilet (not supplied).
- *Connect the 3" DWV plumbing pipe* (not supplied) from the toilet to the composting unit. The waste pipe should be installed 45° or more to the vertical, and/or a 2° to 3° angle (that is a drop of 1/8" - 1/4" per ft.) so that the waste travels with the liquid.

Do-It-Yourself Installation

- Install multiple toilets using a "Y" fitting above the waste inlet of the composteer.
- Limit horizontal distances to 15-20ft where possible. Although we do not recommend it, units have been placed up to 40ft away. In such cases clean-out fittings and extra flush throughs will be needed, and difficulties may occur.

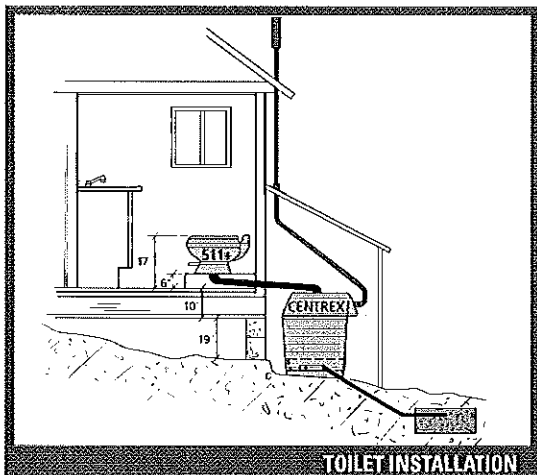

Installation with platform mounted Model 511+ where height is a problem

Units Using a Dry Toilet

- Bolt the Dry Toilet to the floor immediately above the waste inlet of the AF (water free) unit. The toilet chute extends 4" below the toilet base so that it can sleeve into the 45" long waste pipe piece, or directly into the waste inlet transition piece. The 45" long 10" diameter pipe piece supplied can be cut to size, so the toilet mounting surface can be anywhere from 36½" to 81½" above the surface the composteer is placed on.
- The maximum recommended height of the waste inlet pipe assembly, is the length of the pipe piece (45") plus the waste inlet transition piece (5"). Adding additional pipe lengths, while possible, may make it more difficult to ensure there is a downdraft at the toilet seat.

A second toilet is not possible when using a Dry Toilet.

OPERATION OF ONE PINT FLUSH TOILETS

The most popular type of CENTREX is a **water flush unit** which uses a One Pint Flush Toilet. The water flush and water seal of the One Pint Flush Toilet ensures **odorless operation**, and makes this unit most similar to a traditional toilet.

A handsome ceramic One Pint Flush Toilet in the bathroom (available in white or bone) is connected using regular 3" plumbing pipe to the CENTREX composteer which should be placed below and within **15-20 feet of the toilet**.

The toilet has no water tank. It is flushed by a foot pedal which opens a water valve, discharging waste while pushed down, and filling the bowl when lifted. After flushing, a small amount of water is held in the toilet bowl, which is sealed by a teflon and rubber seal.

Even gravity fed water from a roof tank is sufficient to flush this toilet, and in winter they can be **flushed manually** using a container.

More than one toilet can be installed with CENTREX units. The limitation is the number of people using the toilet rather than the number of toilets. The regular choice is the Model 510+ which offers a regularly sized bowl and toilet seat with a 17½" height.

In some instances **extra height is needed** to allow the toilet to gravity feed to the composting unit. Where this is the case, the Model 511+ (low profile model) with a 13" seat height can be **mounted on a platform**, and the waste pipe can then go through the wall, which reduces the installation height needed.

SPECIAL FEATURES OF MOBILE UNITS

Mobile units differ from all other units in that they use a 3" vent stack, and a "fan box" with a 12 Volt 4.0 Watt fan which is installed in the 3" vent stack.

This fan is on a separate circuit and should be kept on to **ensure odors are eliminated**.

The fan box also incorporates filter materials to scrub the air in the stack, since in many cases the Mobile units are vented at deck level. Installers should select a suitable deck vent for the particular installation.

The Mobile units feature the same sized

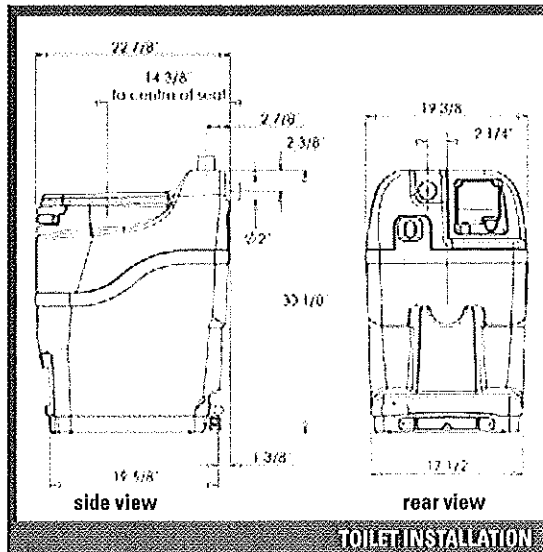
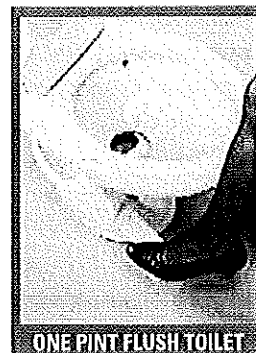

Bio-drum™ as the Spacesaver. Because they are designed to accommodate violent motion, they have mounting brackets, gasketed finishing drawers, spill-proof air intakes, and a drum lock that locks the Bio-drum™ in position at all times. A special detachable footrest folds back into the unit to minimize space requirements.

Mobile units feature a thermostatically controlled 115Volt 160Watt heater in the heater base, which can be activated to improve evaporation performance **whenever 115Volt A/C power is available**. As an option a second 12 Volt 120 Watt heater is available for Mobile units where there is plenty of 12 Volt DC power. All units feature a 1" drain, and on Mobile units there is a required hook up to a small holding tank, removable container, or other approved facility.

As with other self contained units the Mobile units have hard smooth shiny finish which is easy to clean.

HANDLING EXCESS LIQUID

Electric self contained units (Excel, Compact and Spacesaver) and all electric Central units with a Dry Toilet **will evaporate all liquids** under normal operation. Even so, as a safety measure SUN-MAR recommends that safety drains be connected. A 10ft 1" drain hose and clamp is included on all Central units and on the Excel NE and Spacesaver and this should be connected.

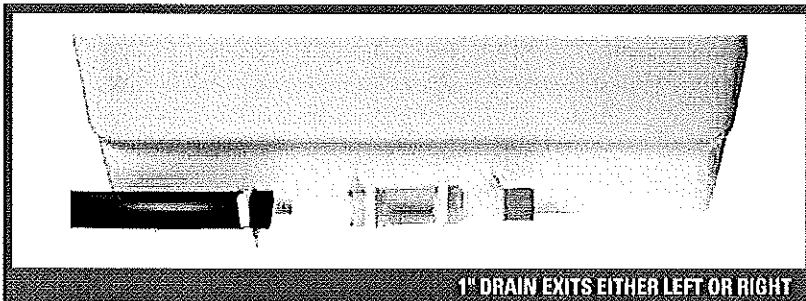

1" DRAIN EXITS EITHER LEFT OR RIGHT

- Collect and/or treat excess liquid in an approved facility such as a recycling bed, old septic system, holding tank or drain pit.
- To make a closed loop system that does not touch the environment in any way, simply dig a **recycling bed** 18" deep and line it with plastic sheet. Fill it with 6" gravel, 12" of sand, and plant with grass or shrubs. Depending on the model chosen and the local climate, the bed will normally be from 3 – 25sq ft. Contact SUN-MAR for more information.
- **Drain pits** for excess liquid should be installed in accordance with local regulations. In many areas, this is about 1ft deep and 2ft in diameter. Place a sturdy cover (plastic, tin or wood) and a 6" mound of earth over the drain to prevent soil and surface water from settling into the gravel.

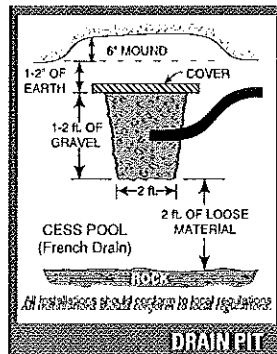

THE HISTORY OF SUN-MAR

For over a quarter century, SUN-MAR has been the world leader in home composting technology. Here are some of the milestones.

- ▶ **1971**
 - The first self contained composting toilet is developed by the father of one of the Sun-Mar partners.
- ▶ **1977**
 - The first Central composting unit, (forerunner of all Centrex units) is designed and launched.
- ▶ **1979**
 - The first three chamber composting system with Bio-drum™ is introduced.
- ▶ **1981**
 - The first non-electric self-contained unit is introduced by SUN-MAR.
- ▶ **1989**
 - The Excel becomes the first self-contained composting toilet to pass the National Sanitation Foundation (NSF) long term composting tests. Today the Excel remains the only such unit listed.
- ▶ **1991**
 - The first dual vented unit is introduced for use with a non-continuous 115 Volt power supply.
- ▶ **1994**
 - SUN-MAR awarded US patent for Bio-drum™ design.
 - SUN-MAR introduces the SUN-MAR Mobile, the first self-contained composting toilet designed for marine and RV markets.
- ▶ **1997**
 - The first continuous flow composting unit is introduced by SUN-MAR. This high capacity unit automatically moves the compost through the unit and into a collection chamber as the drum rotates.
- ▶ **2000**
 - SUN-MAR awarded US patent for double drum.
 - SUN-MAR awarded US patent for continuous flow design for self-contained units.
- ▶ **2006**
 - Double drum technology used to produce SUN-MAR 200 and 400 Garden Composters.

WARRANTY

ALL UNITS CARRY A COMPREHENSIVE 3 YEAR PARTS REPLACEMENT WARRANTY.

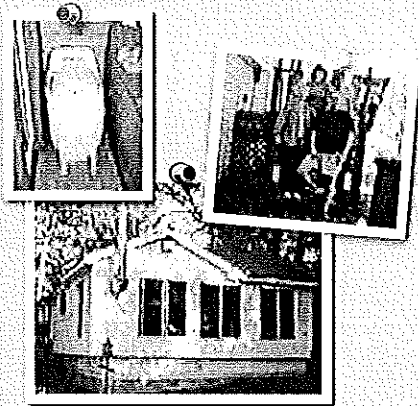

▲ XCEL — Installed 2002

The McWilliams Family Cottage — Tweed, Ontario

The McWilliams have been happy with their UN-MAR EXCEL for a number of years. "Our UN-MAR Excel was installed in our new cottage bathroom in July of 2002. We love it! Our cottage is near a river and so a septic was not an option. I tell everyone about how great this toilet is. I even told our local Rotary Club! We have never had a smell or a problem." And we will be there for them if they ver do!

▼ XCEL AC/DC's — Installed 2002

Birch Pond Lodge — Willow, AK - www.birchpondlodge.com



Birch Pond Lodge was named one of the Top 10 Eco-Resorts in the world by Outside Magazine, and has appeared in a book called "Wilderness Lodge Vacations", also by Outside magazine. Additionally, they have been named one of the Top 25 Eco-Resorts in the world by Travel and Leisure Magazine. After receiving these honors, the proprietor wrote to UN-MAR to share the good news with us. According to him, "Using UN-MAR composting toilets has solved the problem of disturbing the ground for a septic tank and drain field and eliminated the possibility of contamination of our lakes and ponds". UN-MAR is very proud to have been chosen by Birch Pond Lodge to meet their sanitation needs for their guests, and protect a little slice of pristine Alaskan wilderness.

EXCEL NE — Installed 2000

usan and Patrick Radtke — Cabin in Saxeville, WI

In 2000, the Radtkes installed their XCEL NE in their cabin in Wisconsin. They have been thrilled with it. "The UN-MAR XCEL N has been the perfect choice for our cabin in the woods. The electricity often goes off so this was a great worry-free solution. We have had no problems and absolutely no odors! We even trained our son to use it from the time that he was toddler." We hope that UN-MAR will be part of the Radtkes cabin experience for many years to come.



◀ COMPACT — Installed 1996

Julie Wyatt — Pacific North West

When Julie had the opportunity to install the environmentally sound system of her choice, she said she "did a lot of research before choosing a UN-MAR." She advises, "I've used your composting toilet on a daily basis for the past five years. It has served me well, and especially now because our well, like so many around here, has all but dried up. I might also add that your product and your service are absolutely TOPS. I've enjoyed every contact I've had with your company!"

MOBILE (Hull Shape) — Installed 1996

Captain Magic, Ketch Inca — Somewhere on the High Seas

Andrew Yellen (Capt. Magic) must be one of the most colorful characters around. He bought and installed his MOBILE when he was visiting Key West. He reports, "I am thrilled and delighted with our UN-MAR Marine Sanitation Device (MSD). The MOBILE operates cleanly, efficiently, and absolutely without the odor and messiness of standard holding tanks." He also likes the fact that he can operate without two through-the-hull fittings. "Because of the possibility that the MOBILE will vent at deck level, there is a place for zeolite and carbon filter in the fan box if needed. In Capt. Magic's case it wasn't. He feels that "filters in the stack are over-kill".



CENTREX 3000 NE — Installed 2004 ▼

Paul Billinge — Greece

'We live on an olive grove covering four terraces overlooking the Bay of Messinia in South West Greece. We have a Sun Mar CENTREX 3000 NE which has proved to be excellent and we can only say how pleased we are with its performance. Further it is far more economic to install than conventional sewage systems and is undoubtedly much more efficient and ecological. Thank you UN-MAR " Paul was so enthused about our product that he now sells them throughout Europe."

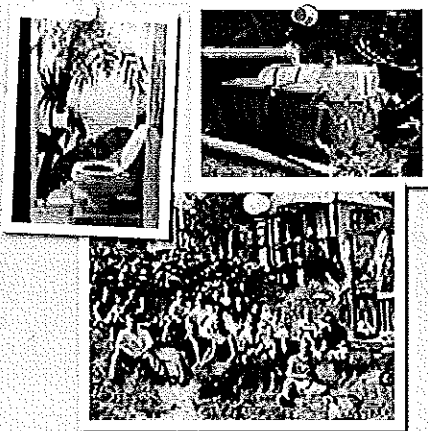

▲ CENTREX 2000 NE and EXCEL NE — Installed 2003

*Eco-Lodge Rendez Vous Saba — West Indies
www.ecolodge-saba.com*

The staff of Eco-Lodge Rendez Vous SABA were looking for a waste solution that would "leave no trace" on their exotic Caribbean eco-resort. They found it in UN-MAR as excerpts from their letter to us attest: "The Ecolodge Rendez-Vous is located in a moist tropical climate at almost 1,700 ft elevation. It consists of a restaurant and 12 guest cottages that each sleeps up to 4 persons. We have equipped 2 cottages with the EXCEL NE composting toilets and the remaining 10 with CENTREX 2000 NE systems and a Sealand 1-pint flush toilet (visible at bottom right in the photograph of the bedroom). Both systems work beautifully and require very little maintenance. So far, we have had no problems with non-biodegradable objects in the toilets and our guests are entirely happy with the product. As we are totally dependent upon rainwater collected in cisterns for all our water supply, the water saving aspect

◀ CENTREX 1000 — Installed 1995

Barbara Kinner — Redwood, NY

When Barbara built her beautiful home on the Lake, she had to work out how to deal with the problem of building on solid rock. Luckily, a friend suggested what she describes as the perfect answer, a CENTREX. When Barbara's family visits there are as many as 12-15 people. She is "very satisfied with the unit cost wise and maintenance wise", and has recommended the unit to several people. We are really pleased about that!

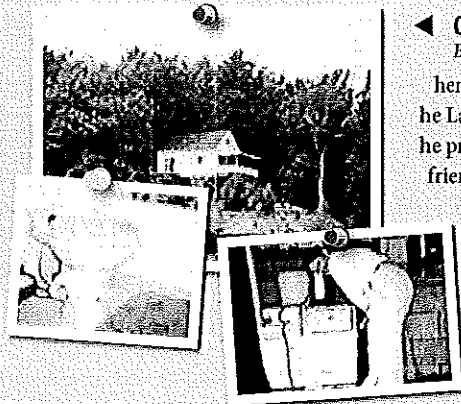

CENTREX 1000 and TROPIC — Installed 1997 and 1979 ▼

Mr. and Mrs. G.K. Caldwell and family — Caldwell Island, ON

Mr. and Mrs. Caldwell have the earliest known North American produced UN-MAR (a 1979 TROPIC) in continuous operation on their Island in the St. Lawrence River between Canada and the U.S. The Caldwells shown here in front of their cottage in a picture taken some years ago, recently upgraded to a CENTREX 1000 and put their old TROPIC into their children's cottage on the Island. Eleanor, their grand-daughter, and the third generation of composters, is shown posing with the raised and very colorful toilet installation for the new Caldwell CENTREX 1000. Meanwhile Mr. Caldwell is showing his tomato plants which he feeds with compost extracted each spring from the TROPIC. The Caldwell's use their toilet continuously from early spring to late fall, "when I get frozen out", says Mr. Caldwell.



SUN-MAR GARDEN COMPOSTERS

Finally Composting Made Easy!

SUN-MAR's new range of garden composters incorporate our patented, double drum, Autoflow® designs. In these units material goes in the top and compost exits out the end as the drum rotates.

UNIQUE AUTOFLOW® FEATURES

- Compost Discharges Automatically
- Pest Resistant
- No Waiting For Batches To Finish
- Loads And Turns Easily

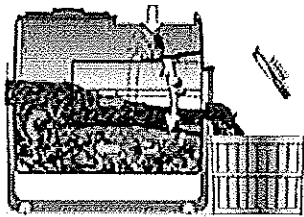

SUN-MAR 200

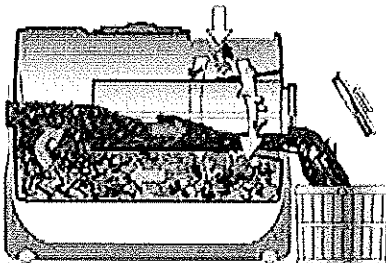

SUN-MAR 400

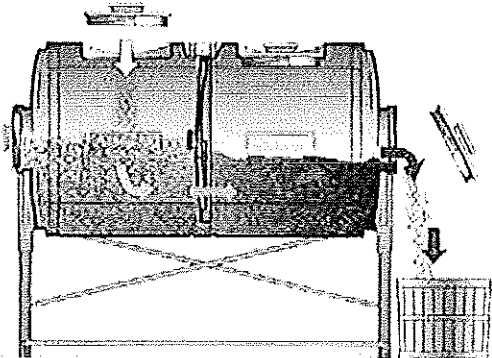

SUN-MAR 600



SUN-MAR 200

For More Information On SUN-MAR Garden Composters
Ask For A Free 8-page Color Catalog

Call 1-888-341-0782

Tel: 905-332-1314 • Fax: 905-332-1315 • Email: compost@sun-mar.com
www.gardencomposter.com • www.sun-mar.com

US Office
600 Main St.
Tonawanda, NY
14150-0888

Canadian Office
5370 South Service Rd.
Burlington, ON
L7L 5L1

istributed by:

SUN-MAR reserves the right to make product modifications or technical changes without notice (03/07) warranty.